

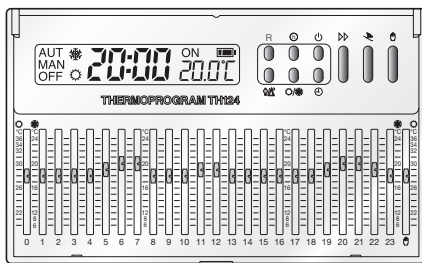

Cronotermostato programmabile

FB00802M04



TH/124

MANUALE DI INSTALLAZIONE ED USO

IT	Italiano
EN	English
FR	Français
DE	Deutsch

Avvertenze generali

- ⚠️ Importanti istruzioni per la sicurezza delle persone: **LEGGERE ATTENTAMENTE!**
- Assicurarsi che la rete di alimentazione, conformemente alle regole di installazione, sia provvista di dispositivo di disconnessione onnipolare, che consenta la protezione per categoria di sovratensione III.
- L'installazione, la programmazione, la messa in servizio e la manutenzione devono essere effettuate da personale qualificato ed esperto e nel pieno rispetto delle normative vigenti.
- Indossare indumenti e calzature antistatiche nel caso di intervento sulla scheda elettronica.
- Conservare queste avvertenze.
- Togliere sempre l'alimentazione elettrica durante le operazioni di pulizia o di manutenzione.
- Il prodotto deve essere destinato solo all'uso per il quale è stato espressamente studiato. Ogni altro uso è da considerarsi pericoloso.
- Il costruttore non può comunque essere considerato responsabile per eventuali danni derivanti da usi impropri, erronei ed irragionevoli.
- ⚠️ Pericolo di esplosione se le batterie vengono sostituite con altre di tipo errato.
- Le batterie, una volta esaurito il loro ciclo di vita, non devono essere gettate con i rifiuti indifferenziati, ma raccolte separatamente ed avviate a corretto recupero.

SMALTIMENTO - Assicurarsi che il materiale d'imballaggio non venga disperso nell'ambiente, ma smaltito seguendo le norme vigenti nel paese di utilizzo del prodotto.

Alla fine del ciclo di vita dell'apparecchio evitare che lo stesso venga disperso nell'ambiente. Lo smaltimento dell'apparecchiatura deve essere effettuato rispettando le norme vigenti e privilegiando il riciclaggio delle sue parti costituenti. Sui componenti, per cui è previsto lo smaltimento con riciclaggio, sono riportati il simbolo e la sigla del materiale.

Riferimenti normativi - Il prodotto è conforme alle direttive di riferimento vigenti.

Descrizione dispositivo

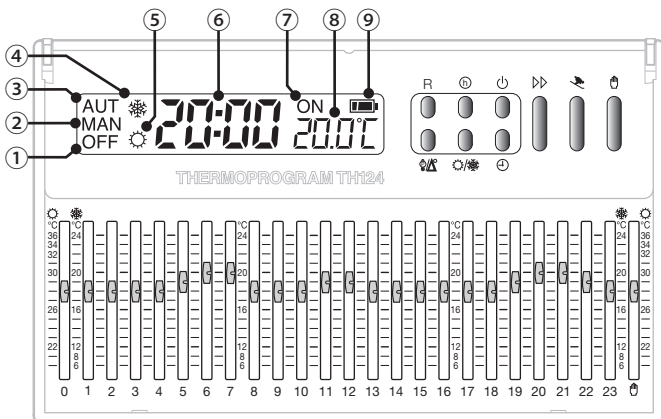

Descrizione delle icone sul display

- | | | | |
|---|-----------------------------------------------------------|---|----------------------------------------------------|
| ① | OFF Zona termica esclusa dal controllo | ⑤ | Modalità raffreddamento attiva |
| ② | MAN Controllo MANUALE della zona termica attivo | ⑥ | Orologio digitale |
| ③ | AUT Controllo AUTOMATICO della zona termica attivo | ⑦ | ON Riscaldatore o raffrescatore in funzione |
| ④ | Modalità riscaldamento attiva | ⑧ | Temperatura rilevata |
| | | ⑨ | Stato di carica delle batterie |

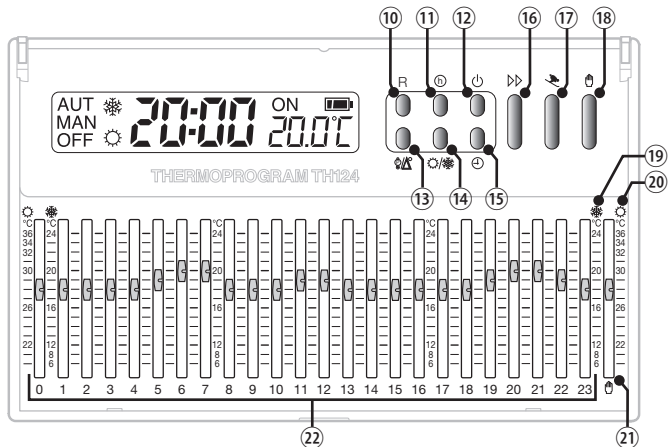

Funzione di pulsanti e cursori

- | | |
|---------------------------------------------------------------------------------|----------------------------------------------------------------------------------------------|
| <p>⑩ R Pulsante di reset</p> | <p>⑲ Scala delle temperature valida con modalità riscaldamento attiva</p> |
| <p>⑪ Visualizza il tempo di attivazione impianto</p> | <p>⑳ Scala delle temperature valida con modalità raffreddamento attiva</p> |
| <p>⑫ Esclude il controllo sulla zona termica</p> | <p>㉑ cursore per la selezione della temperatura manuale</p> |
| <p>⑬ Visualizza la temperatura ed il differenziale termico impostato</p> | <p>㉒ Cursori per la selezione delle temperature desiderate nelle diverse ore del giorno</p> |
| <p>⑭ Selezione della modalità di funzionamento dell'impianto</p> | |
| <p>⑮ Regolazione dell'ora</p> | |
| <p>⑯ Pulsante di avanzamento</p> | |
| <p>⑰ Attiva il programma vacanze</p> | |
| <p>⑱ Selezione del programma di controllo dell'impianto MANUALE/AUTOMATICO</p> | |

ATTENZIONE!

La pulizia del dispositivo va effettuata usando solamente un panno morbido inumidito con acqua.

Installazione

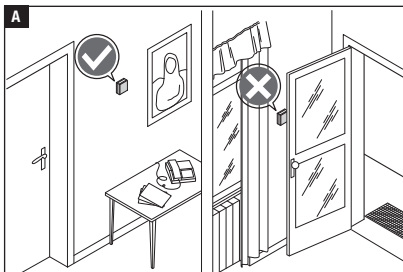

Installare l'apparecchio in posizione idonea a rilevare correttamente la temperatura dell'ambiente, possibilmente in una parete interna, evitando l'installazione in nicchie, dietro a porte, a tende o vicino a sorgenti di calore.

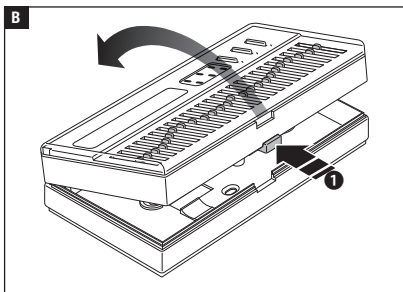

Premere il pulsante **1** e separare la base dal corpo del dispositivo **B**.

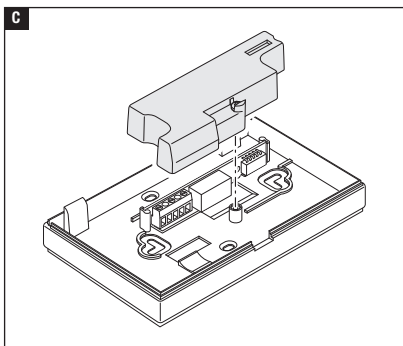

Rimuovere il guscio protettivo dalla morsettiera **C**.

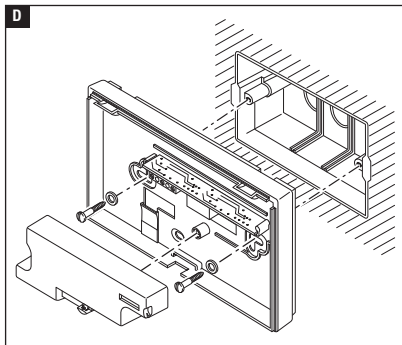

Fissare la base alla parete o alla scatola da incasso facendo passare i cavi di collegamento attraverso l'apposita apertura **D**.

Nota. Non serrare con troppa forza le viti di fissaggio.

Collegamenti elettrici

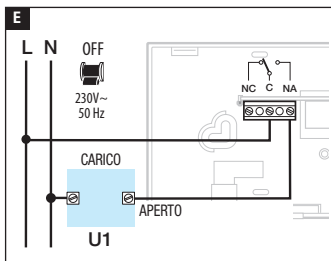

I collegamenti vanno effettuati in funzione del tipo di apparecchiatura comandata dal cronotermostato.

LEGENDA

Conduttori di alimentazione da rete

N = neutro

L = fase

Contatti del relé

C = comune

NA = contatto normalmente aperto

NC = contatto normalmente chiuso

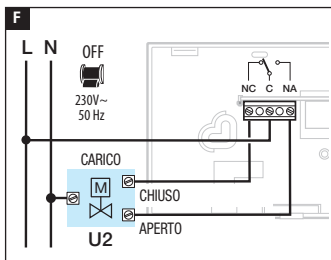

Carichi

U1 = bruciatore, pompa di circolazione, elettrovalvola, ecc.

U2 = valvola motorizzata

NOTA. Per il collegamento fare riferimento alla documentazione tecnica del dispositivo da comandare.

Rimettere il coprimorsetti nella propria sede.

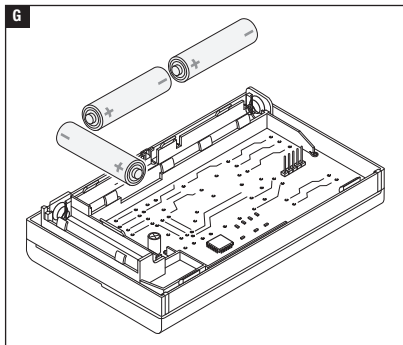

Inserire n. 3 pile alcaline LR03 tipo mini stilo AAA da 1,5V, nell'apposita sede rispettando le polarità indicate sul fondo dell'alloggiamento **G**.

⚠ L'errato posizionamento delle pile può danneggiare l'apparecchio.

Qualora le indicazioni sul display non dovessero comparire entro 30 secondi, premere il pulsante di reset R.

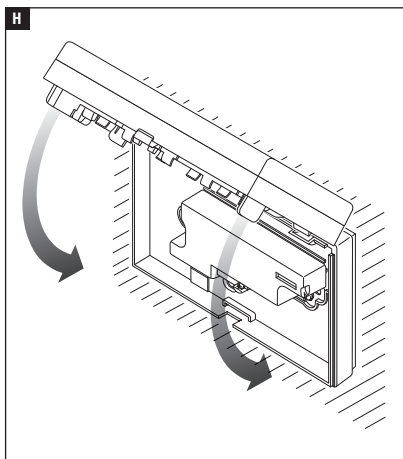

Agganciare il dispositivo alla base come mostrato in figura **H**.

Programmazione e uso del dispositivo

Impostazione dell'orologio

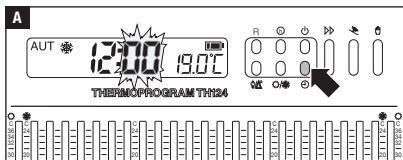

Premere il pulsante **A**.
Le cifre dei minuti lampeggiano.

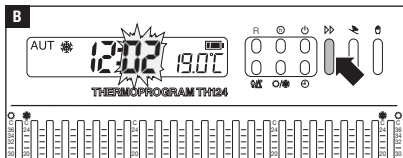

Usare il pulsante per impostare il valore esatto dei minuti **B**.

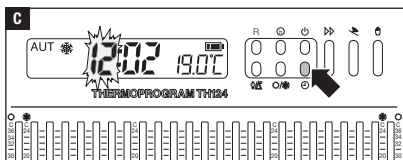

Premere il pulsante **C**.
Le cifre delle ore lampeggiano.

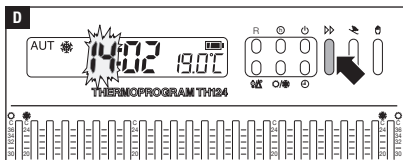

Usare il pulsante per impostare l'ora esatta **D**.

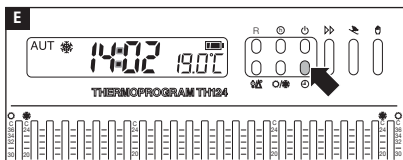

Premere il pulsante per terminare la procedura **E**.

I due punti fra ore e minuti lampeggiano confermando la conclusione dell'operazione.

Nota. Ad ogni pressione sul pulsante  le cifre sul display avanzano di una unità. Mantenendo premuto il pulsante, le cifre sul display si susseguono lentamente per i primi 5 secondi, poi più velocemente.

Nota. Dopo 10 secondi di inattività, l'apparecchio esce autonomamente dalla procedura memorizzando gli ultimi dati impostati.

Impostazione della modalità di funzionamento

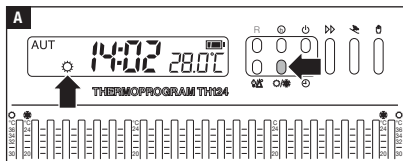

Premere il pulsante  **A** per scegliere la modalità di funzionamento della zona termica.

-  Riscaldamento.
-  Raffrescamento.

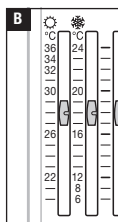

 Con la modalità raffrescamento attiva, le temperature selezionabili mediante i cursori sono comprese tra 36 °C e 34 °C con intervalli di 2 °C tra 32 e 20 °C con intervallo di 1 °C.

 Con la modalità riscaldamento attiva, le temperature selezionabili mediante i cursori sono comprese tra 24 e 12 °C con intervallo di 1 °C, e tra 8 °C e 6 °C con intervallo di 2 °C.

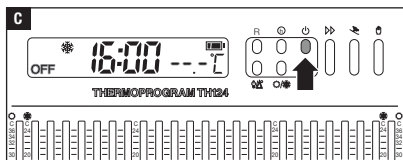

Esclusione dell'impianto

Premere il pulsante  **C**.

Sul display compare l'indicazione OFF e per 5 secondi scompare l'indicazione della temperatura ambiente rilevata.

Il dispositivo è escluso dal controllo della temperatura della zona termica, rimane attivo l'orologio ed il rilevamento della temperatura ambientale.

Premere il pulsante  per ripristinare il controllo sulla zona termica.

Controllo della temperatura AUTOMATICO o MANUALE

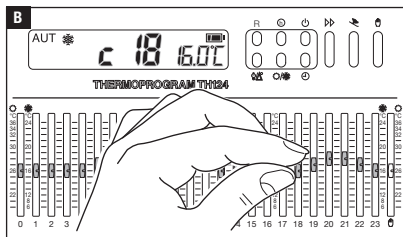
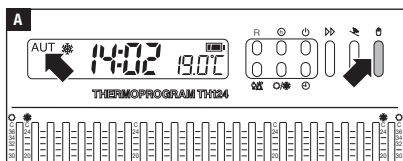

Fare riferimento alle scale  e  a seconda della modalità di funzionamento dell'impianto.

Nota. La programmazione è modificabile in ogni momento semplicemente spostando i cursori nella posizione desiderata.

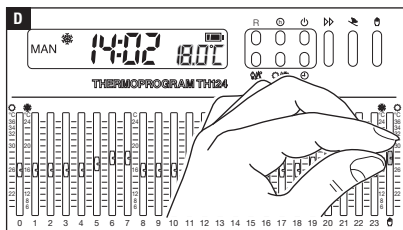
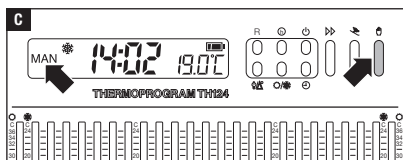

Controllo automatico

Premere il pulsante  **A** fino alla comparsa dell'indicazione **AUT** sul display.



Agire sui cursori 0 ÷ 23 **B**, posizionandoli in corrispondenza della temperatura desiderata, per ogni ora della giornata.

Il display mostra il numero del cursore sul quale si sta agendo e la temperatura che si sta impostando.

Controllo manuale

Premere il pulsante  **C** fino alla comparsa dell'indicazione **MAN** sul display.

Agire sul cursore  **D** posizionandolo in corrispondenza della temperatura desiderata.

Il display mostra la temperatura che si sta impostando. Fare riferimento alle scale  e  a seconda della modalità di funzionamento dell'impianto.

Utilizzo del programma VACANZE

Nel caso si desideri mantenere una temperatura fissa per alcune ore o alcuni giorni (ad esempio per mantenere più a lungo una temperatura confortevole durante visite non previste o una temperatura antigelo di sicurezza durante assenze invernali) è possibile attivare il programma VACANZE.

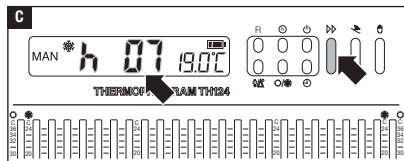
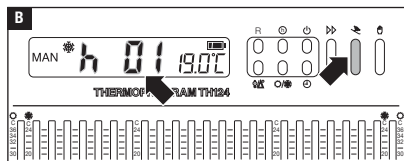
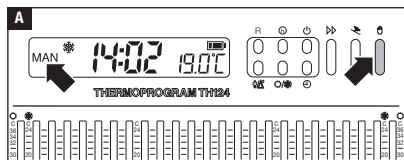

Attivazione oraria

Attivare la modalità di funzionamento MANUALE **A**.

Agire sul cursore  posizionandolo in corrispondenza della temperatura desiderata.

Premere il pulsante  **B**.

Sul display, al posto dell'indicazione dell'ora corrente, compare la scritta h01.

Usare il pulsante  per impostare il numero di ore di attivazione desiderate (da 1 a 99) **C**.

L'attivazione a termine ha inizio immediatamente; il display mostra le ore mancanti al completamento dell'esecuzione del programma. Il residuo dell'ora in corso viene conteggiata come 1 ora.

Nota. Per ritornare al funzionamento AUTOMATICO prima dello scadere del tempo programmato, premere il pulsante  **A**.

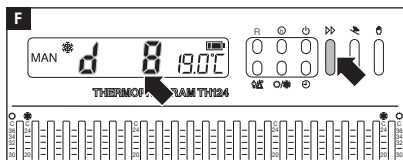
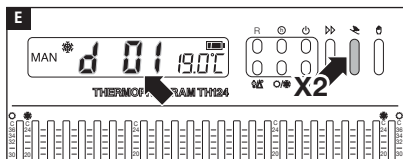
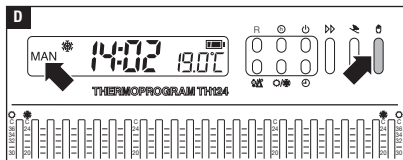

L'attivazione a termine ha inizio immediatamente; il display mostra i giorni mancanti al completamento dell'esecuzione del programma. Il residuo del giorno in corso viene conteggiato come 1 giorno.

*Nota. Per ritornare al funzionamento AUTOMATICO prima dello scadere del tempo programmato premere il pulsante **D**.*

Esclusione temporizzata del controllo della zona termica

Il programma funziona in modo analogo al programma VACANZE, con la differenza che a venire temporizzata è l'esclusione del controllo termico dell'impianto.

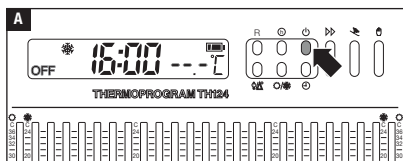

Attivazione giornaliera

Attivare la modalità di funzionamento MANUALE **D**.

Agire sul cursore posizionandolo in corrispondenza della temperatura desiderata.

Premere per due volte il pulsante **E**.

Sul display, al posto dell'indicazione dell'ora corrente, compare la scritta d01.

Usare il pulsante per impostare il numero di giorni di attivazione desiderati (da 1 a 99) **F**.

Esclusione oraria

Premere il pulsante **A**.

Sul display compare l'indicazione OFF e per 5 secondi scompare l'indicazione della temperatura ambiente rilevata.

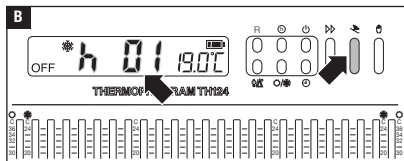

Premere il pulsante  **B**.
Sul display, al posto dell'indicazione dell'ora corrente, compare la scritta h01.

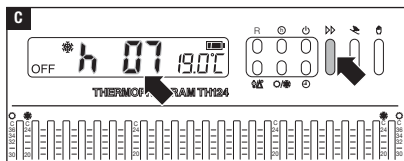



Usare il pulsante  per impostare il numero di ore nel corso delle quali il controllo termico della zona sarà escluso (da 1 a 99) **C**.

L'esclusione a termine ha inizio immediatamente; il display mostra le ore mancanti al completamento dell'esecuzione del programma. Il residuo dell'ora in corso viene conteggiata come 1 ora.

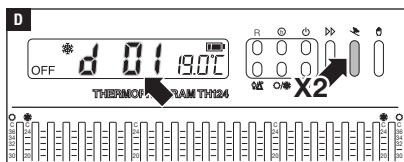
Nota. Per ritornare in funzionamento AUTOMATICO prima dello scadere del tempo programmato premere il pulsante .



Esclusione giornaliera

Premere il pulsante  **A**.
Premere per due volte il pulsante  **D**.
Sul display, al posto dell'indicazione dell'ora corrente, compare la scritta d01.

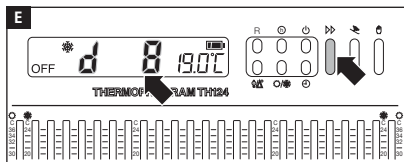

Usare il pulsante  per impostare il numero dei giorni nel corso dei quali il controllo termico della zona sarà escluso (da 1 a 99) **E**.

L'esclusione a termine ha inizio immediatamente; il display mostra

i giorni mancanti al completamento dell'esecuzione del programma. Il residuo del giorno in corso viene conteggiato come 1 giorno.

Nota. Per ritornare al funzionamento AUTOMATICO prima dello scadere del tempo programmato premere il pulsante .

Variare il valore del differenziale termico

Le impostazioni di fabbrica prevedono che il dispositivo operi con un differenziale termico di $\pm 0,2\text{ }^{\circ}\text{C}$.

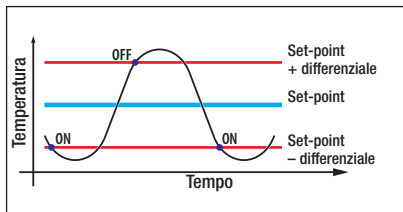

Questo intervallo termico di intervento è adatto per impianti con alta inerzia termica come, ad esempio, impianti con radiatori in ghisa.

Qualora la caratteristica dell'impianto renda necessario variare tale valore, procedere come segue.

Premere il pulsante \odot/Δ° per 2 volte **A**.

Sul display compare, per 10 secondi il valore differenziale programmato ($0,2^{\circ}\text{C}$).

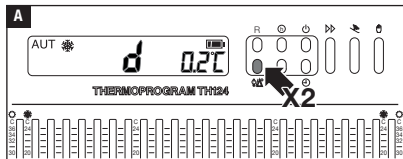

Premere il pulsante $\triangleright\triangleright$ fino a raggiungere il valore differenziale desiderato (da $\pm 0,1\text{ }^{\circ}\text{C}$ a $\pm 0,9\text{ }^{\circ}\text{C}$).

Dopo circa 10 secondi o premendo nuovamente il pulsante \odot/Δ° il display torna a mostrare l'ora e la temperatura ambiente.

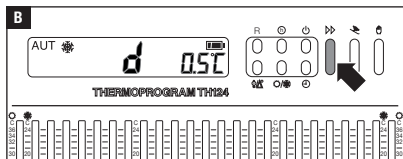

Nota. Premendo il pulsante R il differenziale termico viene riportato alle impostazioni di fabbrica ($\pm 0,2\text{ }^{\circ}\text{C}$).

Visualizzare le temperature programmate

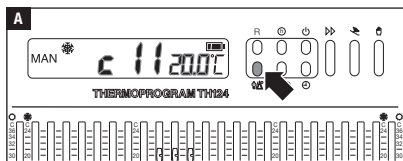

Premere il pulsante ☀/❄.

Sul display compare, per 5 s, il valore della temperatura impostata relativa all'ora indicata **A**.

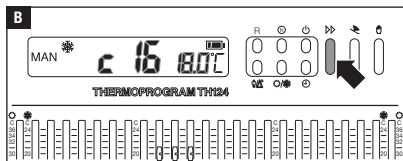

Per esempio se sono le ore 11.45 ed il cursore relativo (C11) è posizionato sui 20°C, sul display comparirà l'indicazione C11 20°C.

Premere il pulsante ⇨⇨ per visualizzare la temperatura programmata per le altre ore del giorno dai diversi cursori. Con C25 viene identificato il cursore della temperatura manuale.

Ore di attivazione dell'impianto

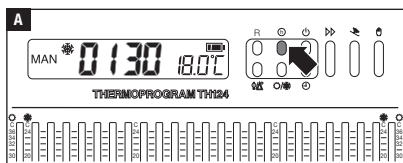



Premere il pulsante (h).

Sul display compare, per 5 secondi, il numero di ore di funzionamento del raffrescatore o riscaldatore collegati al cronotermostato **A**.

Per azzerare il contatore, premere in successione (entro 5 secondi) il pulsante (h) e successivamente il pulsante ⏻.

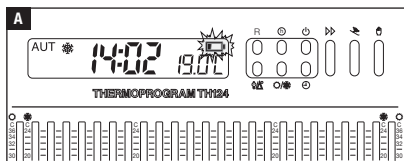
Sostituzione delle batterie



L'icona  lampeggiante sul display **A** indica che le batterie devono essere sostituite entro 1 mese circa.

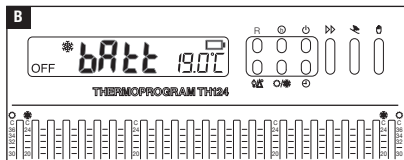

Quando sul display compaiono le indicazioni **batt** + , l'apparecchio non è più operativo e il controllo sulla zona termica è stato disabilitato.

ATTENZIONE: La mancata sostituzione in tempo utile delle batterie può causare danni al sistema di riscaldamento.

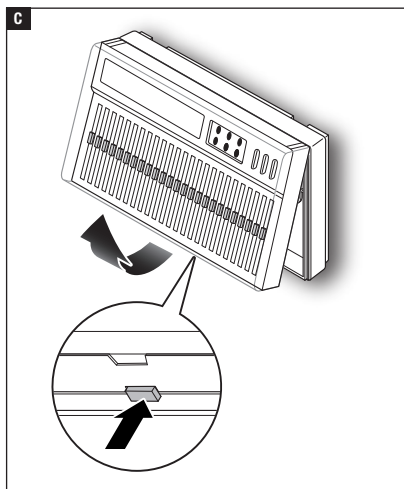

Premere il pulsante situato sul fondo ed aprire l'apparecchio **C**.

Questa operazione, effettuata con l'indicatore di pile scariche lampeggiante, fa sì che tutte le indicazioni sul display scompaiano.

Il tempo a disposizione per sostituire le pile è di circa 2 minuti; trascorso tale tempo le impostazioni configurate verranno resettate alle impostazioni di fabbrica.

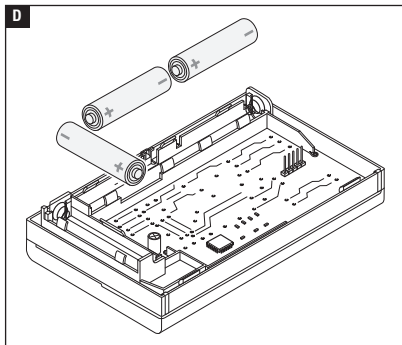

Inserire n.3 pile stilo alcaline LR6, tipo AA da 1,5 V, nuove e dello stesso tipo, rispettando le polarità indicate sul fondo dell'alloggiamento **D**.

Qualora le indicazioni sul display non dovessero comparire entro 30 secondi, premere il pulsante di reset R.

Attenzione. L'errato posizionamento delle pile può danneggiare l'apparecchio.

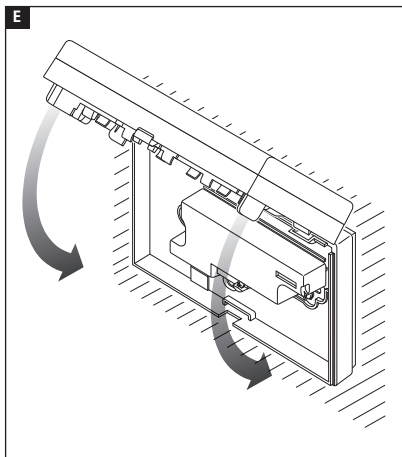

Richiudere l'apparecchio facendo attenzione ad inserire i ganci nelle rispettive sedi **E**.

Dopo qualche secondo le indicazioni sul display ricompaiono.

Risoluzione di eventuali anomalie di funzionamento

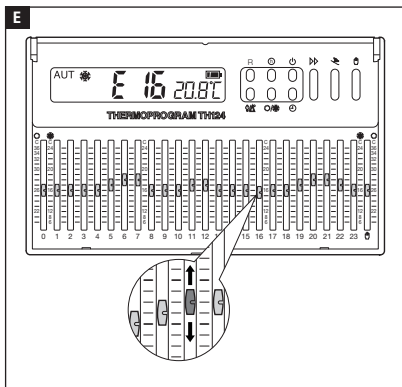

Nel caso si verificassero anomalie di funzionamento, premere il pulsante di reset R.

Questa operazione riporta l'apparecchio alle condizioni di fabbrica.

La comparsa sul display di una indicazione di errore (E) seguita da un numero **E**, si riferisce alla posizione errata di uno dei cursori (da 00 a 25).

Riallineare il cursore segnalato per ripristinare il normale funzionamento dell'apparecchio.

Caratteristiche tecniche

- Apparecchio per uso civile.
- Dispositivo elettronico a montaggio indipendente.
- Display LCD.
- Alimentazione: 3 pile stilo alcaline LR6 Tipo AA da 1,5V.
- Autonomia: oltre 1 anno.
- Relè: tensione massima 250 V, corrente massima 5A con carico resistivo (2A con carico induttivo).
- Tipo di azione: 1B-U.
- Intervallo di rilevamento della temperatura ambiente: 15 s.
- Differenziale termico: da $\pm 0,1$ °C a $\pm 0,9$ °C, selezionabili.
- Risoluzione di lettura: 0,1 °C.
- Campo di lettura visualizzata: da 0 °C a +40 °C.
- Precisione: $\leq \pm 0,3$ °C.
- Software di classe A.
- Grado d'inquinamento: 2.
- Tensione impulsiva: 4 kV.
- Temperatura massima della testa di comando: 40 °C.
- Temperatura di funzionamento: da 0 °C a +40 °C.
- Grado di protezione: IP30.
- Dimensioni: 132x82x33,5 mm.

CAME 
BPT

CAME.COM

CAME S.P.A.

Via Martiri Della Libertà, 15
31030 Dosson di Casier - Treviso - Italy
tel. (+39) 0422 4940 - fax. (+39) 0422 4941



Programmable thermostat

FB00802-EN

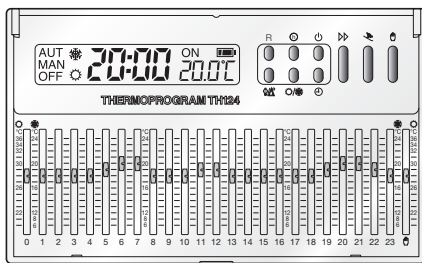

TH/124

INSTALLATION AND USE MANUAL

EN English

General Precautions

- ⚠ Important people-safety instructions: READ CAREFULLY!
- Make sure that the power supply network, in compliance with the installation rules, is fitted with a two-wait cut off switch, that provides category III protection levels;
- Installing, programming, commissioning and maintenance must only be done by qualified, expert staff and in full compliance with the applicable law.
- Wear antistatic protective clothing when working on the control board.
- Keep these precautions.
- Always cut off the mains power when doing cleaning and maintenance jobs.
- This product must only be used for its specifically intended purpose. Any other use is dangerous.
- The manufacturer declines all liability for any damage as a result of improper, incorrect or unreasonable use.
- ⚠ Using unsuitable batteries can lead to an explosion.
- Once the batteries are flat, dispose of in accordance with the law.



DISPOSAL Make sure the packaging material is not disposed of in nature, but rather disposed of in compliance with the laws in effect in the country in which the product is being used. At the end of the product's life cycle, make sure it is not disposed of in nature. The equipment must be disposed of in compliance with current laws and its components recycled where possible. The components that should be recycled are marked with the material's ID marker.

Pertinent Regulations - The product complies with current pertinent legislative standards.

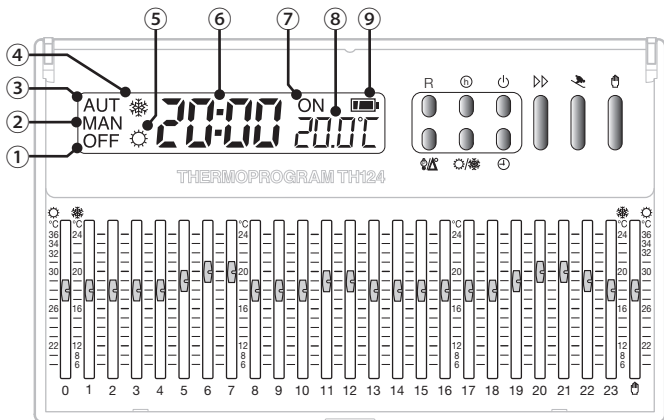
Device description



Description of the icons shown on the display

- | | | | |
|--------------------------------------------------------------------------------------|-------------------------------------------------|--------------------------------------------------------------------------------------|-------------------------------|
| ① OFF | Thermal zone excluded from control | ⑤  | Cooling mode active |
| ② MAN | MANUAL control of the thermal zone | ⑥ | Digital clock |
| ③ AUT | AUTOMATIC control of the thermal zone is active | ⑦ ON | Heater or cooler in operation |
| ④  | Heating mode active | ⑧ | Detected temperature |
| | | ⑨  | Battery-charge state |

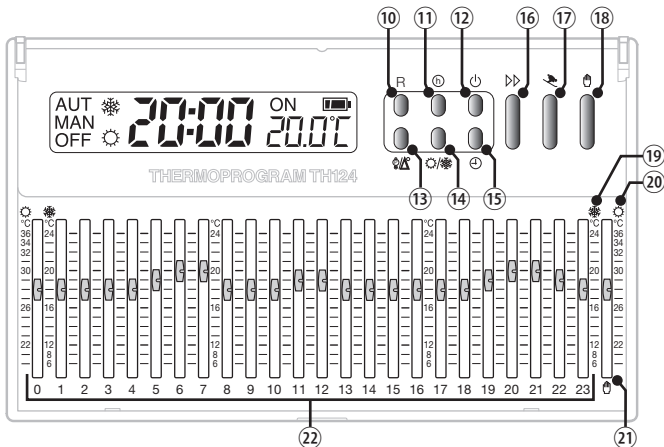

Function of buttons and cursors

- | | | | | |
|----|-------|---------------------------------------------------------|----|-----------------------------------------------------------------------|
| 10 | R | Reset button | 20 | Range of valid temperatures with active cooling mode |
| 11 | (h) | Show system activation time | 21 | Cursor for manually selecting temperature |
| 12 | ⏻ | Exclude control of thermal zone | 22 | Cursors for selecting the temperatures wanted at various times of day |
| 13 | 🌡️ | View the set temperature and temperature differential | | |
| 14 | ⚙️/❄️ | Select the system's operating mode | | |
| 15 | ⌚ | Adjusting the time | | |
| 16 | ▶▶ | Forward button | | |
| 17 | 🏠 | Activate the vacation program | | |
| 18 | 👉 | Select the system's MANUAL or AUTOMATIC control program | | |
| 19 | | Range of valid temperatures with active heating mode | | |

WARNING!

To clean the device, only use a soft moist cloth.

Installing

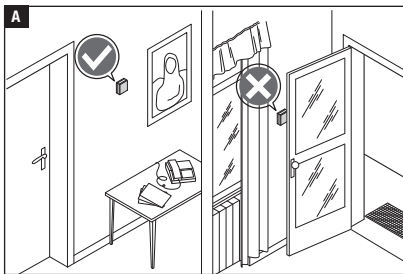

Install the device in a place suitable for detecting the room's temperature, possibly onto an inside wall, and avoid any nooks, behind doors, near curtains or heat sources.

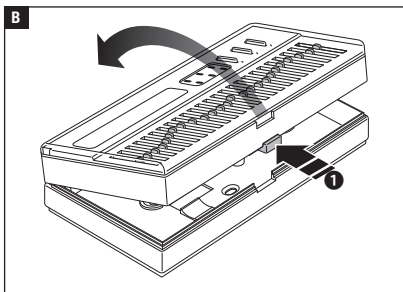

Press button **1** and separate the base from the body of the device **B**.

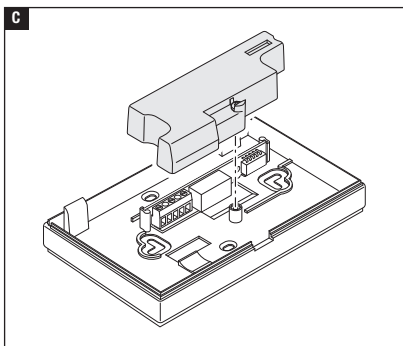

Remove the protective shell from the terminal board **C**.

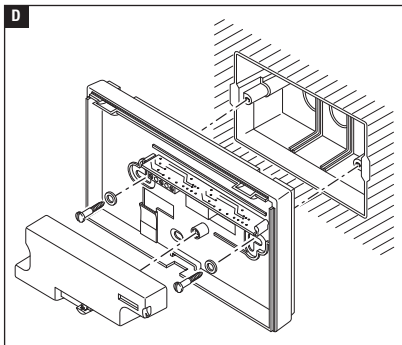

Fasten the base to the wall or to the recess-mounting box while threading the connection cables through the corresponding opening **D**.

Note. Do not excessively tighten the screws.

Electrical connections

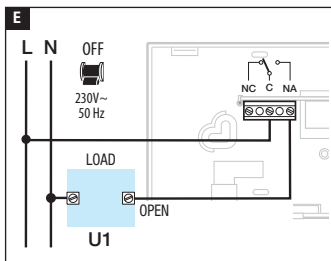

The connections must be suitable for the devices controlled by the chronothermostat.

LEGEND

Mains power-supply conductors

N = neutral

L = phase

Relay contacts

C = common

NA = contact normally open

NC = contact normally closed

Loads

U1 = burner, circulation pump, electric valve, etc..

U2 = motor-powered valve

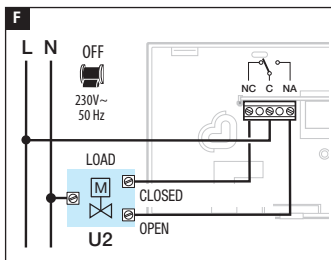

NOTE. For connections, please refer the corresponding technical literature.

Replace the terminal caps.

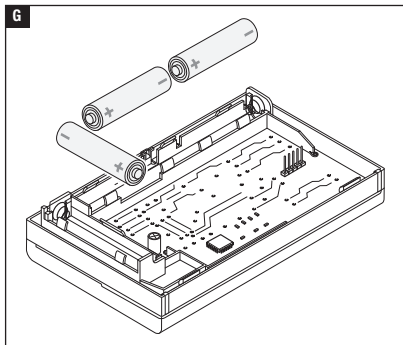

Fit three LR03 alkaline AAA 1.5V batteries, into the battery housing while respecting the polarities shown on the bottom **G**.

⚠ *Wrongly fitted batteries can damage the device.*

If the indications on the display do not appear within 30 seconds, press the R reset button.

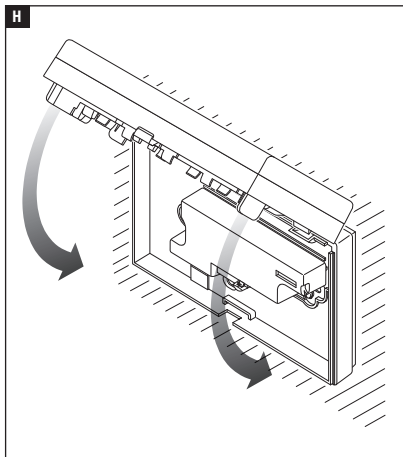

Latch the device onto the base as shown in the figure **H**.

Programming and using the device

Setting the clock

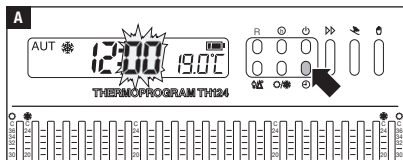

Press button **A**.

The minute digits are flashing.

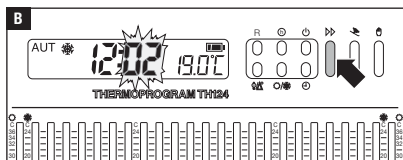

Use the button to set the exact minute value **B**.

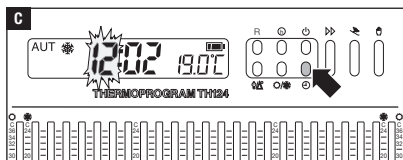

Press button **C**.

The hours digits are flashing.

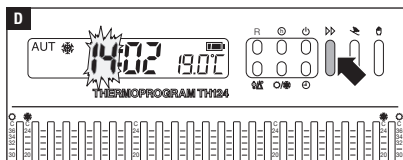

Use the button to set the exact time **D**.

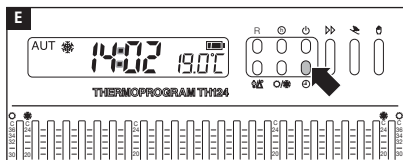

Press button to end the procedure **E**.

The colon between the minutes and hours are flashing to confirm that the procedure is done.

Note. Each time the button is  pressed, the digits on the display advance by one unit. By keeping the button pressed, the digits on the display slowly increase for five seconds, then quickly increase.

Note. After 10 seconds of inactivity, the device automatically exits the procedure while memorizing the latest set data.

Setting the operating modes

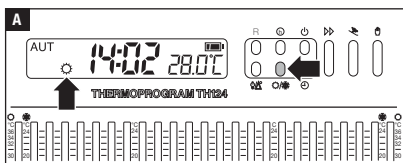

Press button  **A** to choose the thermal zone's operating mode.

-  Heating.
-  Cooling.

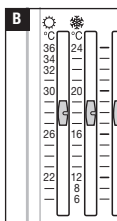

 With the cooling mode on, the temperatures you can select by using the cursor range between 36°C and 34 °C with 2° intervals and between 32°C and 20 °C with 1° intervals.

 With the heating mode on, the temperatures you can select by using the cursor range between 24°C and 12°C with 1° intervals and between 8°C and 6 °C with 2° intervals.

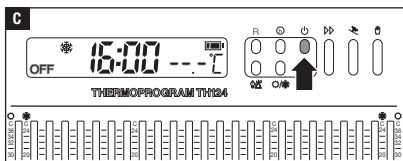

Exclude system

Press button  **C**.

The display wording reads OFF and for 5 seconds the detected room-temperature disappears.

The device is excluded from the

thermal zone's temperature control. The clock and the room-temperature reading remain active.

Press button  to restore control over the thermal zone.

AUTOMATIC or MANUAL temperature control

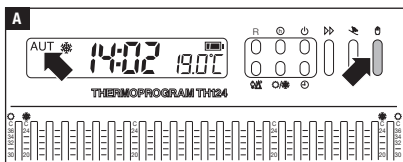

Automatic control

Press button **A** until the wording AUT appears on the display.

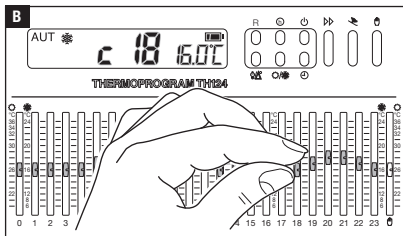

Move cursors 0 to 23 **B**, placing them on the wanted temperature, for each hour of the day. The display shows the cursor number on which you are working and the temperature that you are setting.

Use scales  and  according to the system's operating mode.

Note. The programming can be changed at any time by simply moving the cursor to the position required.

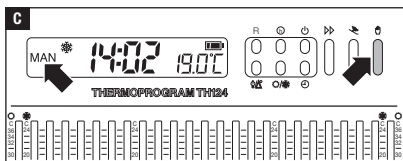

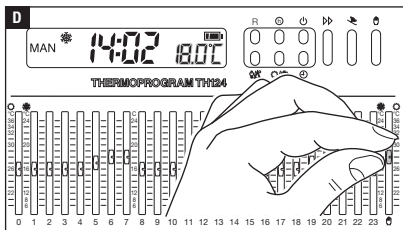

Manual control

Press button **C** until the wording MAN appears on the display.



Place cursor **D** on the temperature you want.

The display shows the temperature that you are setting. Use scales  and  according to the system's operating mode.

Using the VACATION program

If you want to maintain a steady temperature for some hours or days - for example to keep the most comfortable temperature during when hosting guests or to prevent freezing during winter absences - you can activate the VACATION program.

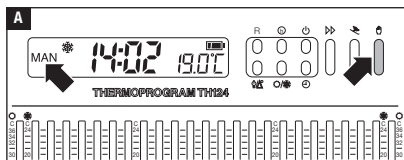

Hourly activation

Activating the MANUAL operating mode **A**.

Place the cursor  on the temperature you want.

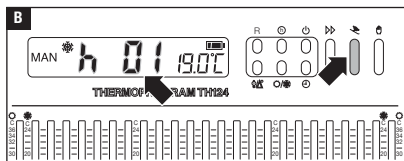

Press button  **B**.

The display shows the wording h01 instead of the current time.

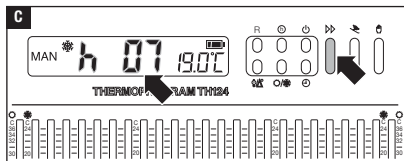

Use button  to set the number of wanted hours of activation (from 1 to 99) **C**.

The activation term starts immediately; the display shows the hours left for completing the execution of the program. The residual current hour is counted as one hour.

Note. To return to AUTOMATIC operating mode before the set time elapses, press button  **A**.

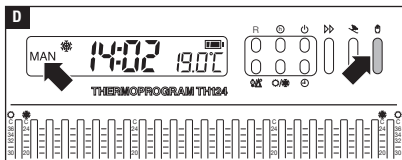

Daily activation

Activating the MANUAL operating mode **D**.

Set the cursor  on the temperature you want.

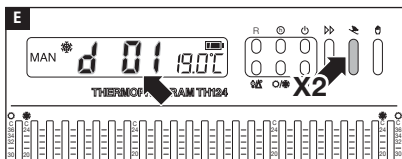

Press button  **E** twice.

The display, in place of the current time indication, will show the wording d01.

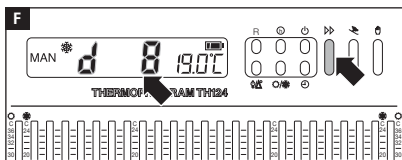

Use button  to set the number of wanted days of activation (from 1 to 99) **F**.

The activation term starts immediately; the display shows the days left to complete the execution of the program. The residual part of the day is counted as 1 day.

Note. To return to AUTOMATIC operating mode before the set time elapses, press button  **D**.

Exclusion term for controlling the thermal zone

The program runs analogically in VACATION mode, except that it is the system's thermal control to be given a set term.

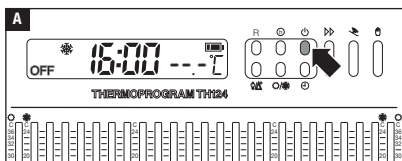

Excluding time

Press button  **A**.

The display wording reads OFF and for 5 seconds the detected room-temperature disappears.

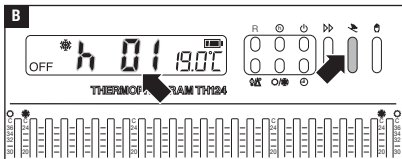

Press button  **B**.
The display shows the wording h01 instead of the current time.

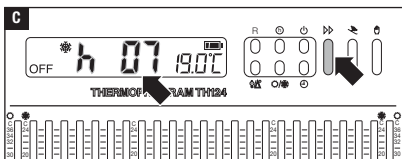



Use button  to set the number of hours during which the thermal control of the zone will be excluded (from 1 to 99) **C**.

The set exclusion starts immediately; the display shows the hours left for completing the execution of the program. The residual current hour is counted as one hour.

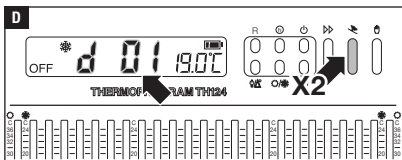
Note. To return to AUTOMATIC operating mode before the set time elapses, press button .



Daily exclusion

Press button  **A**.
Press button twice  **D**.
The display, in place of the current time indication, will show the wording d01.

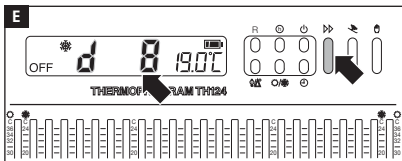

Use button  to set the number of days during which the thermal control of the zone will be excluded (from 1 to 99) **E**.

The set exclusion starts immediately; the display shows the days

left to complete the execution of the program. The residual part of the day is counted as 1 day.

Note. To return to AUTOMATIC operating mode before the set time elapses, press button .

Change the value of the temperature differential

The factory settings have a $\pm 0.2^{\circ}\text{C}$ temperature differential. This temperature differential is suitable for high thermal-inertia systems, such as, systems with cast iron radiators.

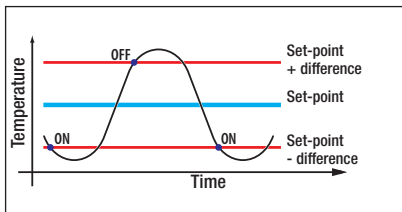

If you need to change that value, proceed in the following way:

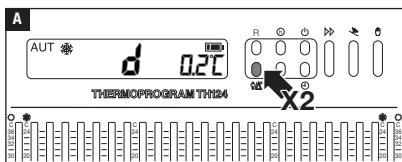

Press button R/Δ° twice **A**.

The display will show, for 10 seconds, the value of the set temperature differential (0.2°C)

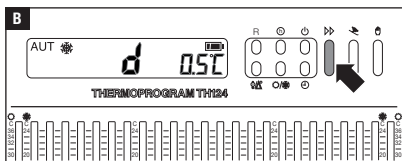

Press button \gg until the desired temperature difference value is reached between $\pm 0.1^{\circ}\text{C}$ and $\pm 0.9^{\circ}\text{C}$). After about 10 seconds or by pressing again button R/Δ° the display will show the time and room temperature.

Note. By pressing button **R** the temperature differential is restored to the ($\pm 0.2^{\circ}\text{C}$) factory settings.

View set temperatures

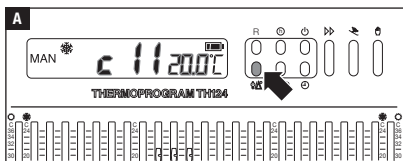

Press button .

The display shows, for 5 seconds, the temperature value corresponding to a chosen time **A**.

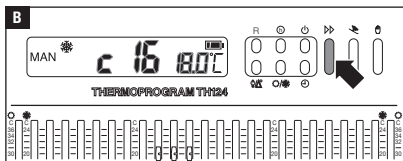

For example, if at 11:45 the C11 cursor is set to 20°C, the display will show C11 20°C.

Press button  to view the set temperature, for other times of day, by the various cursors. C25 represents the manual temperature cursor.

System activation time

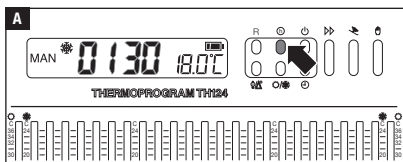



Press button .

The display shows, for 5 seconds, the set number of hours during which either the cooling or heating connected to the chronothermostat will be in operation. **A**.

To zero out the counter, repeatedly press button  and then button  within 5 seconds.

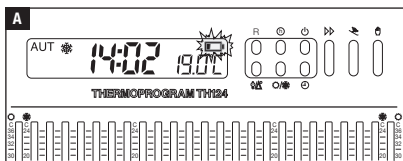
Replacing the batteries



When  the icon is flashing on the display **A** it means the batteries need to be replaced within about one month.

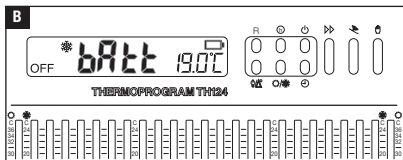

When the display shows **batt** + , the device is no longer operational and the control over the thermal zone has been disabled.

ATTENTION: not replacing the batteries within the two-minute limit may damage the heating system.

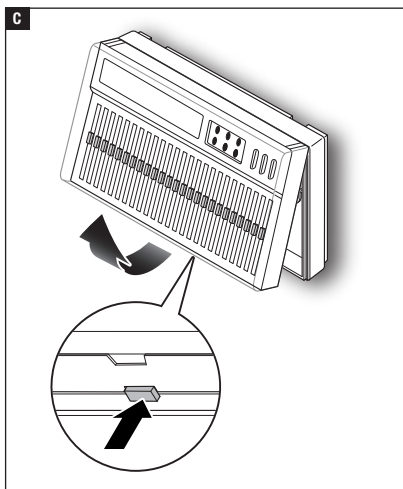

Press the button on the bottom and open the device **C**.

This procedure, done when the battery-charge state icon is flashing, will make all wording on the display disappear.

The time available for replacing the batteries is about 2 minutes; once that time has elapsed the configured settings will be restored to the factory settings.

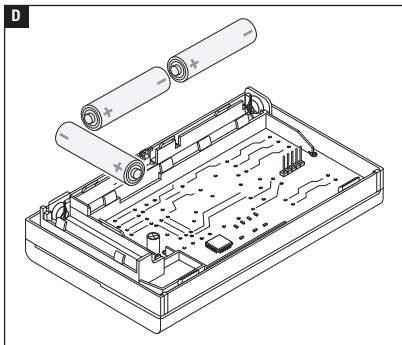

Fit three new LR6 alkaline AA 1.5V batteries, into the battery housing while respecting the polarities shown on the bottom **D**.

If the instructions on the display don't appear within 30 seconds, press the R reset button.

ATTENTION: badly fitted batteries may damage the heating system.

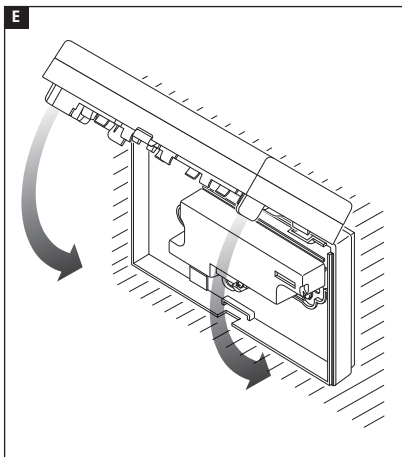

Close the device and be careful with the small latches. **E**.

After some seconds the instructions reappear on the display.

Problem solving

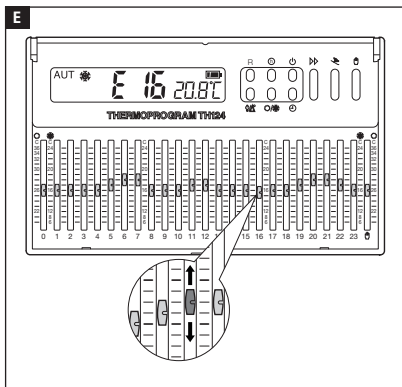

Press the R reset button if there are any malfunctions.

This procedure restores the device to its factory settings.

An error message on the display (E) followed by a number **E**, means that one of the 00 to 25 cursors is in the wrong position.

Realign the flagged cursor to restore the device to normal operating mode.

Technical features

- Device for home and office use.
- Independently mounted electronic device.
- LCD Display .
- Power supply: three alkaline LR6 1.5V AA batteries.
- Battery life: over 1 year.
- Relay switch: maximum voltage 250 V, maximum current 5A with resistive load (2A with inductive load).
- Type of action: 1B-U.
- Room-temperature detection interval: 15 s.
- Temperature differential: from ± 0.1 °C to ± 0.9 °C, selectable.
- Reading resolution: 0.1 °C.
- Reading range displayed: from 0 °C to +40 °C.
- Precision: $\leq \pm 0.3$ °C.
- Class A software.
- Pollution rating: 2.
- Impulse voltage: 4 kV.
- Maximum temperature of the control head: 40 °C.
- Operating temperature: from 0 °C to +40 °C.
- Protection rating: IP30.
- Dimensions: 132x82x33.5 mm.

CAME 
BPT

CAME.COM

CAME S.P.A.

Via Martiri Della Libertà, 15
31030 Dosson di Casier - Treviso - Italy
tel. (+39) 0422 4940 - fax. (+39) 0422 4941



Thermostat programmable

FB00802-FR

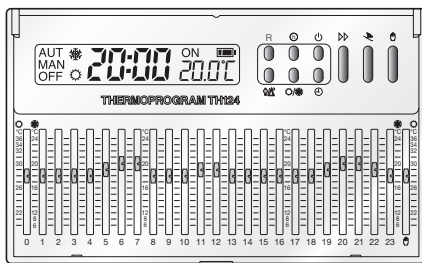

TH/124

MANUEL D'INSTALLATION ET D'UTILISATION

FR Français

Instructions générales

- ⚠ Instructions importantes pour la sécurité des personnes : À LIRE ATTENTIVEMENT !
- S'assurer que le réseau d'alimentation est bien doté, conformément aux règles d'installation, d'un dispositif de déconnexion omnipolaire pour la protection en cas de surtension catégorie III.
- L'installation, la programmation, la mise en service et l'entretien doivent être effectués par du personnel qualifié et dans le plein respect des normes en vigueur.
- Porter des vêtements et des chaussures antistatiques avant d'intervenir sur la carte électronique.
- Conserver ces instructions.
- Toujours couper le courant électrique durant les opérations de nettoyage ou d'entretien.
- Ce produit ne devra être destiné qu'à l'utilisation pour laquelle il a été expressément conçu. Toute autre utilisation est à considérer comme dangereuse.
- Le fabricant décline toute responsabilité en cas d'éventuels dommages provoqués par des utilisations impropres, incorrectes et déraisonnables.
- ⚠ Ne remplacer les piles usagées que par des piles compatibles afin d'éviter tout risque d'explosion.
- Ne pas jeter les piles à la poubelle au terme de leur cycle de vie, mais les collecter séparément en vue d'un recyclage correct.

ÉLIMINATION - S'assurer que le matériel d'emballage n'est pas jeté dans la nature mais qu'il est bien éliminé selon les normes en vigueur dans le pays où le produit est utilisé.

Éviter que l'appareil, au terme de son cycle de vie, ne soit jeté dans la nature. L'élimination de l'appareil doit être effectuée conformément aux normes en vigueur en privilégiant le recyclage de ses composants. Le symbole et le sigle du matériau figurent sur les composants à recycler.

Références normatives - Le produit est conforme aux directives de référence en vigueur.

Description dispositif

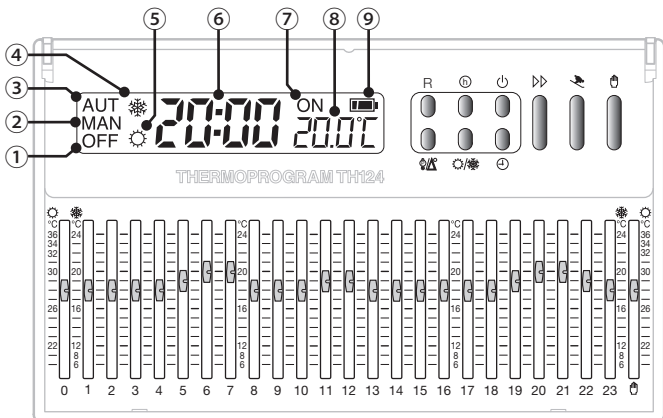

Description des icônes sur l'afficheur

- | | | | | |
|---|------------|--------------------------------------------------|---|--------------------------------------------------|
| ① | OFF | Zone thermique exclue du contrôle | ⑤ | Modalité climatisation activée |
| ② | MAN | Contrôle MANUEL de la zone thermique activé | ⑥ | Horloge numérique |
| ③ | AUT | Contrôle AUTOMATIQUE de la zone thermique activé | ⑦ | ON Réchauffeur ou climatiseur en fonction |
| ④ | | Modalité chauffage activée | ⑧ | Température lue |
| | | | ⑨ | État de charge des piles |

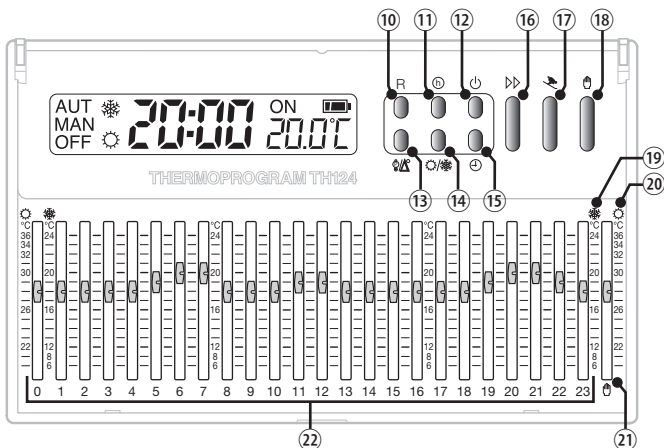

Fonction de boutons et curseurs

- | | | | |
|----------------------------------------------------------------------------------------------|------------------------------------------------------------------------------------------------------------------------------------------------------------------------------------------------------------------------------------------------------------------------------------------------------------------------------------------------------------------------------------------------------------------------------------------------------------------------------------------------------------------|-------------------------------------|------------------------------------------------------------------------------------------------------------------------------------------------------------------------------------------------------------------------------------------------------------------------------------------------------------------------------------------|
| <p>⑩ R</p> <p>⑪ h</p> <p>⑫ </p> <p>⑬ </p> <p>⑭ </p> <p>⑮ </p> <p>⑯ </p> <p>⑰ </p> <p>⑱ </p> | <p>Bouton de remise à zéro</p> <hr/> <p>Visualise le temps d'activation de l'installation</p> <hr/> <p>Désactive le contrôle sur la zone thermique</p> <hr/> <p>Visualise la température et le différentiel thermique configuré</p> <hr/> <p>Sélection du mode de fonctionnement de l'installation</p> <hr/> <p>Réglage de l'heure</p> <hr/> <p>Bouton d'avancement</p> <hr/> <p>Active le programme vacances</p> <hr/> <p>Sélection du programme de contrôle de l'installation
MANUEL/AUTOMATIQUE</p> <hr/> | <p>⑲</p> <p>⑳</p> <p>㉑</p> <p>㉒</p> | <p>Échelle des températures valide avec modalité chauffage activée</p> <hr/> <p>Échelle des températures valide avec modalité climatisation activée</p> <hr/> <p>Curseur pour la sélection de la température manuelle</p> <hr/> <p>Curseurs pour la sélection des températures souhaitées aux différentes heures de la journée</p> <hr/> |
|----------------------------------------------------------------------------------------------|------------------------------------------------------------------------------------------------------------------------------------------------------------------------------------------------------------------------------------------------------------------------------------------------------------------------------------------------------------------------------------------------------------------------------------------------------------------------------------------------------------------|-------------------------------------|------------------------------------------------------------------------------------------------------------------------------------------------------------------------------------------------------------------------------------------------------------------------------------------------------------------------------------------|

ATTENTION !

Nettoyer le dispositif uniquement avec un chiffon doux humidifié d'eau.

Installation

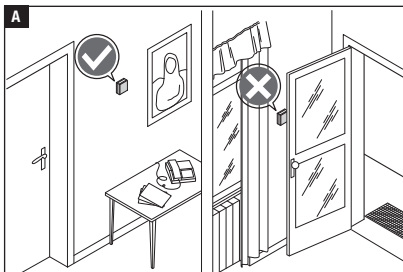

Installer l'appareil dans une position lui permettant de détecter correctement la température ambiante, si possible dans un mur interne, en évitant l'installation dans des ouvertures, derrière des portes, des rideaux ou près de sources de chaleur.

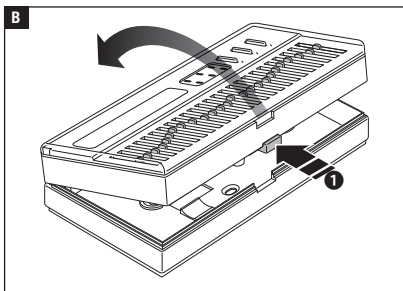

Appuyer sur le bouton **1** et séparer la base du corps du dispositif **B**.

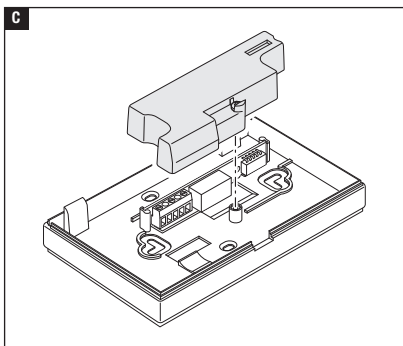

Enlever le couvercle de protection du bornier **C**.

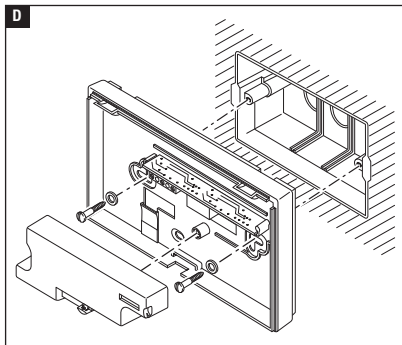

Fixer la base au mur ou au boîtier à encaster en faisant passer les câbles de connexion à travers l'ouverture prévue à cet effet **D**.

Remarque. Ne pas serrer trop fort les vis de fixation.

Branchements électriques

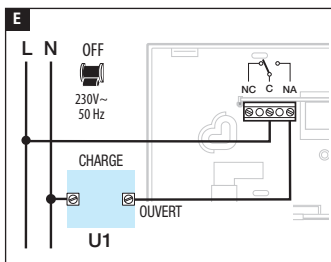

Les connexions doivent être effectuées en fonction du type d'équipement commandé par le thermostat programmable.

LÉGENDE

Conducteurs d'alimentation réseau

N = neutre

L = phase

Contacts du relais

C = commun

NO = contact normalement ouvert

NF = contact normalement fermé

Charges

U1 = brûleur, pompe de circulation, électrovanne, etc.

U2 = vanne motorisée

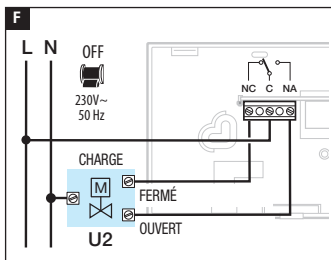

REMARQUE. Pour la connexion, consulter la documentation technique du dispositif à commander.

Remettre en place le cache-bornes.

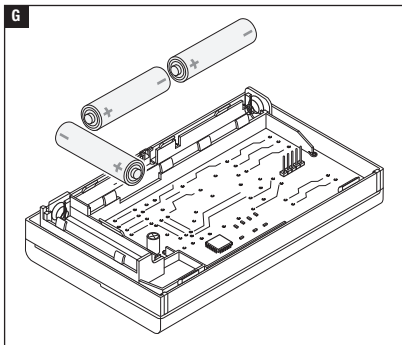

Installer 3 piles alcalines LR03 1,5 V type AAA en respectant les polarités indiquées au fond du logement **G**.

⚠ Le positionnement incorrect des piles peut endommager l'appareil.

À défaut d'affichage des indications dans les 30 secondes qui suivent, appuyer sur le bouton de remise à zéro R.

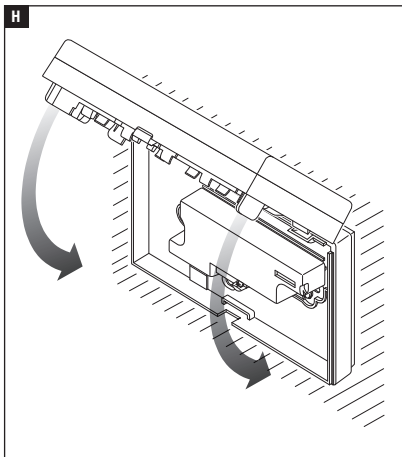

Fixer le dispositif à la base comme indiqué sur la figure **H**.

Programmation et utilisation du dispositif

Configuration de l'horloge

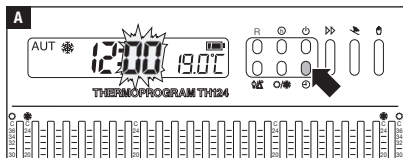

Appuyer sur le bouton  **A**.
Les chiffres des minutes clignotent.

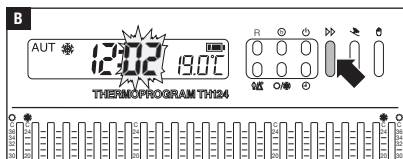

Se servir du bouton  pour configurer la valeur exacte des minutes **B**.

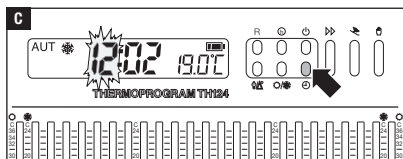

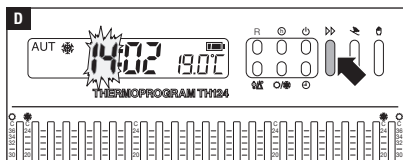

Appuyer sur le bouton  **C**.
Les chiffres des heures clignotent.

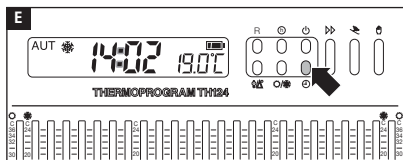

Se servir du bouton  pour configurer l'heure exacte **D**.





Appuyer sur le bouton  pour terminer la procédure **E**.
Les deux points entre les heures et les minutes clignotent pour confirmer la fin de l'opération.

Remarque. À chaque enfoncement du bouton  les chiffres à l'écran augmentent d'une unité. En maintenant ce bouton enfoncé, les chiffres à l'écran se succèdent lentement les 5 premières secondes puis plus rapidement.

Remarque. Au bout de 10 secondes d'inactivité, l'appareil sort de façon autonome de la procédure en mémorisant les dernières données configurées.

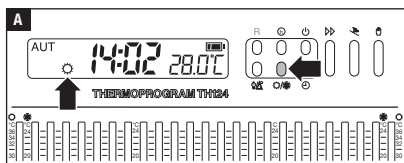
Configuration de la modalité de fonctionnement



Appuyer sur le bouton  **A** pour choisir la modalité de fonctionnement de la zone thermique.

 Chauffage.

 Climatisation.

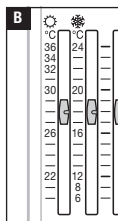

 Avec la modalité climatisation activée, les températures sélectionnables au moyen des curseurs sont comprises entre 36 et 34°C avec des intervalles de 2°C, et entre 32 et 20°C avec un intervalle d'1°C.

 Avec la modalité chauffage activée, les températures sélectionnables au moyen des curseurs sont comprises entre 24 et 12°C avec un intervalle d'1°C, et entre 8 et 6°C avec un intervalle de 2°C.

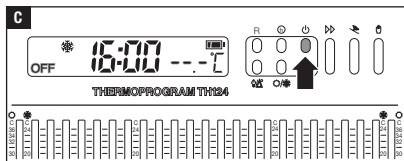

Désactivation de l'installation

Appuyer sur le bouton  **C**.



L'écran affiche l'indication OFF tandis que celle de la température ambiante détectée disparaît pendant 5 secondes.

Le dispositif est exclu du contrôle de la température de la zone thermique alors que l'horloge et la détection de la température ambiante restent activées.

Appuyer sur le bouton  pour rétablir le contrôle sur la zone thermique.

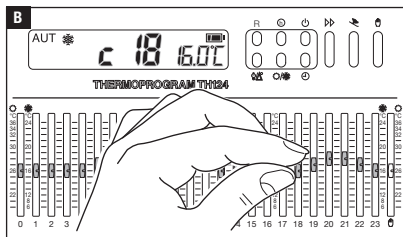
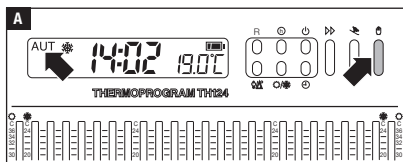
Contrôle de la température AUTOMATIQUE ou MANUEL



Se référer aux échelles  et  en fonction de la modalité de fonctionnement de l'installation.
Remarque. Il est possible de modifier la programmation à tout moment en déplaçant tout simplement les curseurs sur la position souhaitée.

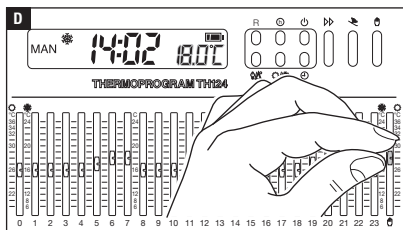
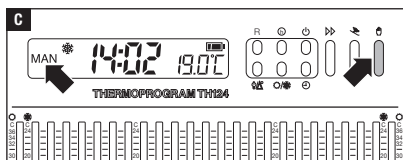

Contrôle automatique

Appuyer sur le bouton  **A** jusqu'à ce que l'écran affiche l'indication AUT.

Intervenir sur les curseurs de 0 à 23 **B** et les positionner au niveau de la température souhaitée pour chaque heure de la journée.

L'écran visualise le numéro du curseur sur lequel l'utilisateur est en train d'intervenir ainsi que la température qu'il est en train de configurer.

Contrôle manuel

Appuyer sur le bouton  **C** jusqu'à ce que l'écran affiche l'indication MAN.

Déplacer le curseur  **D** sur la température souhaitée.

L'écran affiche la température en phase de configuration. Se référer aux échelles  et  en fonction de la modalité de fonctionnement de l'installation.

Utilisation du programme VACANCES

Afin de maintenir une température fixe pendant quelques heures ou quelques jours (ex. : pour maintenir plus longtemps une température confortable durant des visites imprévues ou une température antigel durant des absences en hiver), il est possible d'activer le programme VACANCES.

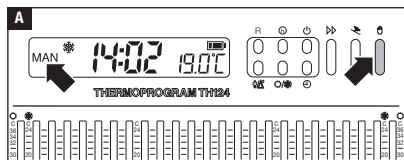

Activation horaire

Activer le mode de fonctionnement MANUEL **A**.

Déplacer le curseur  sur la température souhaitée.

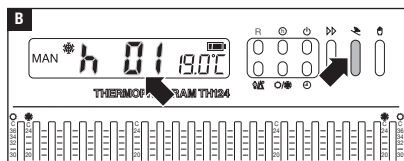

Appuyer sur le bouton  **B**.

À la place de l'heure courante l'écran affiche le message h01.

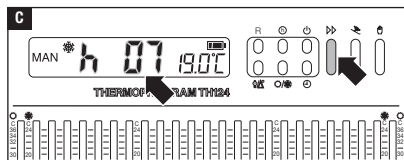

Se servir du bouton  pour configurer le nombre d'heures d'activation souhaité (de 1 à 99) **C**.

L'activation temporisée démarre immédiatement ; l'afficheur indique les heures manquant à l'exécution complète du programme. Le reste de l'heure en cours est considéré comme 1 heure entière.

Remarque. Pour revenir au fonctionnement AUTOMATIQUE avant l'écoulement du temps programmé, appuyer sur le bouton  **A**.

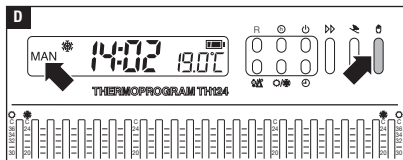

Activation journalière

Activer le mode de fonctionnement MANUEL **D**.

Déplacer le curseur  sur la température souhaitée.

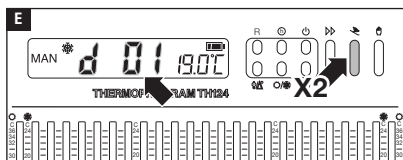

Appuyer deux fois sur le bouton **E**.

À la place de l'heure courante l'écran affiche le message d01.

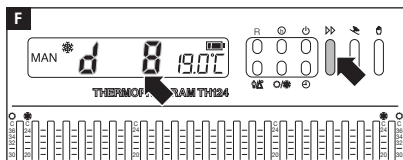

Se servir du bouton **F** pour configurer le nombre de jours d'activation souhaité (de 1 à 99).

L'activation temporisée démarre immédiatement ; l'afficheur indique les jours manquant à l'exécution complète du programme. Le reste du jour en cours est considéré comme 1 jour entier.

Remarque. Pour revenir au fonctionnement AUTOMATIQUE avant l'écoulement du temps programmé, appuyer sur le bouton **D**.

Désactivation temporisée du contrôle de la zone thermique

Le programme fonctionne comme le programme VACANCES sauf que c'est la désactivation du contrôle thermique de l'installation qui est à présent temporisée.

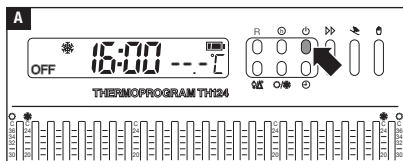

Désactivation horaire

Appuyer sur le bouton **A**.

L'écran affiche l'indication OFF tandis que celle de la température ambiante détectée disparaît pendant 5 secondes.

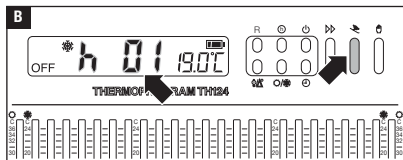

Appuyer sur le bouton  **B**.
À la place de l'heure courante l'écran affiche le message h01.

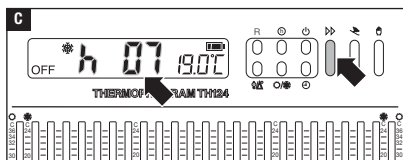



Se servir du bouton  pour configurer le nombre d'heures au cours desquelles le contrôle thermique de la zone sera désactivé (de 1 à 99) **C**.

La désactivation temporisée démarre immédiatement ; l'afficheur indique les heures manquant à l'exécution complète du programme. Le reste de l'heure en cours est considéré comme 1 heure entière.

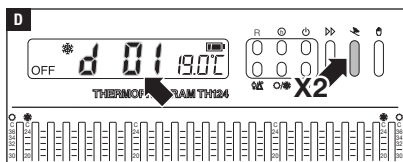
Remarque. Pour revenir au fonctionnement AUTOMATIQUE avant l'écoulement du temps programmé, appuyer sur le bouton .



Désactivation journalière
Appuyer sur le bouton  **A**.
Appuyer deux fois sur le bouton  **D**.
À la place de l'heure courante l'écran affiche le message d01.

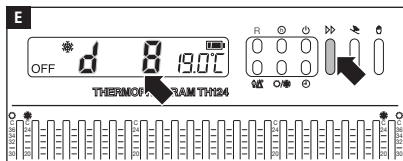

Se servir du bouton  pour configurer le nombre de jours au cours desquels le contrôle thermique de la zone sera désactivé (de 1 à 99) **E**.

La désactivation temporisée démarre immédiatement ; l'afficheur indique les jours manquant à l'exécution complète du programme. Le reste du jour en cours est considéré comme 1 jour entier.

Remarque. Pour revenir au fonctionnement AUTOMATIQUE avant l'écoulement du temps programmé, appuyer sur le bouton .

Modifier la valeur du différentiel thermique

Les configurations d'usine prévoient le fonctionnement du dispositif avec un différentiel thermique de $\pm 0,2^{\circ}\text{C}$.

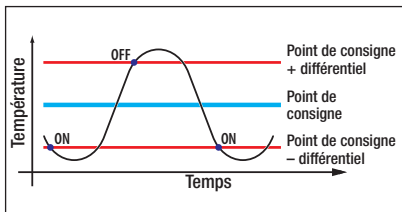

Cet intervalle thermique d'intervention est idéal pour des installations à forte inertie thermique comme, par exemple, les installations avec radiateur en fonte.

Si les caractéristiques de l'installation requièrent la modification de cette valeur, procéder comme suit.

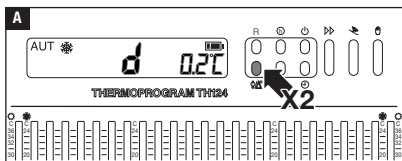

Appuyer 2 fois $\text{⊕}/\Delta^{\circ}$ sur le bouton **A**.

L'écran visualise pendant 10 secondes la valeur différentielle programmée ($0,2^{\circ}\text{C}$).

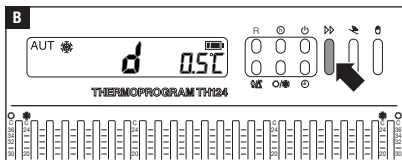

Appuyer sur le bouton \gg jusqu'à atteindre la valeur différentielle souhaitée (de $\pm 0,1^{\circ}\text{C}$ à $\pm 0,9^{\circ}\text{C}$).

Au bout d'environ 10 secondes ou en appuyant à nouveau sur le bouton $\text{⊕}/\Delta^{\circ}$ l'écran affiche à nouveau l'heure et la température ambiante.

Remarque. À l'enfoncement du bouton **R** le différentiel thermique reprend les configurations d'usine ($\pm 0,2^{\circ}\text{C}$).

Visualiser les températures programmées

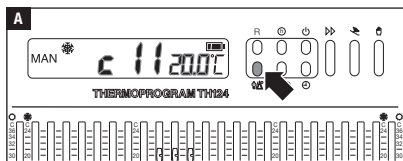

Appuyer sur le bouton .

L'écran affiche pendant 5 s la valeur de la température configurée pour l'heure indiquée **A**.

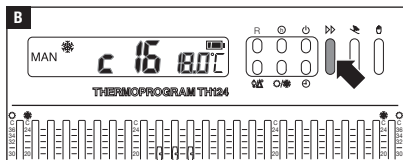

S'il est par exemple 11 h 45 et que le curseur correspondant (C11) est sur 20°C, l'écran visualisera le message C11 20°C.

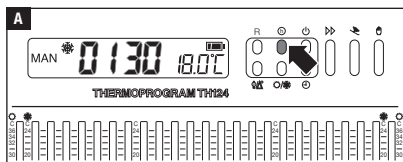

Appuyer sur le bouton  pour visualiser la température programmée pour les autres heures de la journée par les différents curseurs. « C25 » se réfère au curseur de la température manuelle.

Heure d'activation de l'installation





Appuyer sur le bouton .

L'écran affiche pendant 5 secondes le nombre d'heures de fonctionnement du climatiseur ou du réchauffeur connectés au thermostat programmable **A**.

Pour remettre le compteur à zéro, appuyer tout d'abord (dans les 5 secondes qui suivent) sur le bouton  puis sur le bouton .

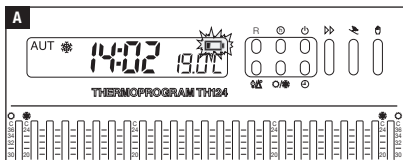
Remplacement des piles



L'icône  clignotant à l'écran **A** indique que les piles doivent être remplacées d'ici 1 mois environ.

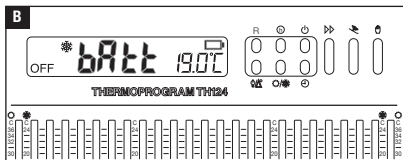

Quand l'écran affiche **bAtt** + , l'appareil ne fonctionne plus et le contrôle sur la zone thermique est désactivé.

ATTENTION : si les piles ne sont pas remplacées à temps, le système de chauffage pourrait se détériorer.

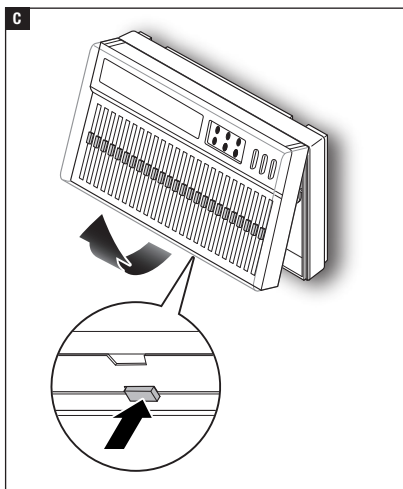

Appuyer sur le bouton au bas et ouvrir l'appareil **C**.

Effectuée lorsque l'indicateur de piles épuisées clignote, cette opération permet de faire disparaître tous les messages à l'écran.

Le temps disponible pour remplacer les piles est d'environ 2 minutes ; au bout de ce délai, les configurations seront réinitialisées.

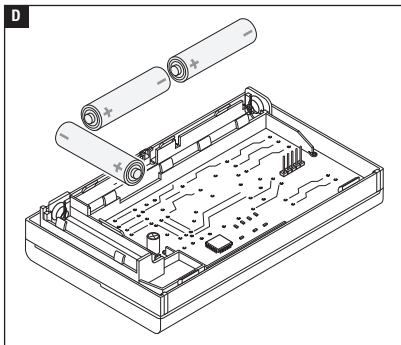

Installer 3 nouvelles piles alcalines LR6 1,5 V type AA en respectant les polarités indiquées au fond du logement **D**.

À défaut d'affichage des indications dans les 30 secondes qui suivent, appuyer sur le bouton de remise à zéro R.

Attention. Le positionnement incorrect des piles peut endommager l'appareil.

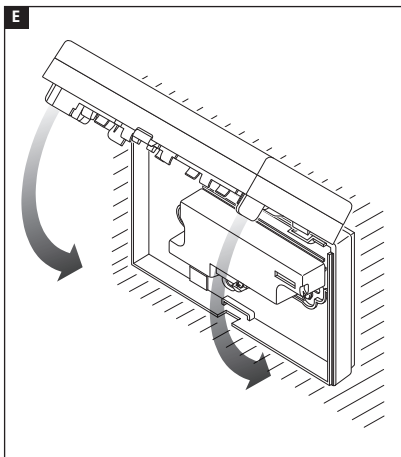

Refermer l'appareil de manière à ce que les deux parties s'emboîtent correctement **E**.

Au bout de quelques secondes les indications réapparaissent à l'écran.

Résolution d'éventuelles anomalies de fonctionnement

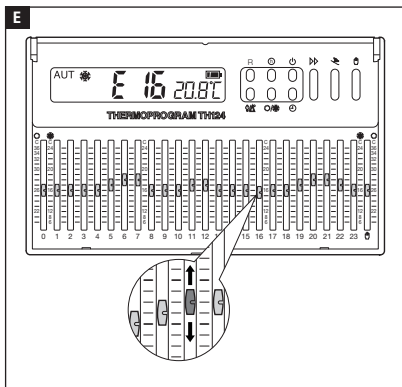

En présence d'anomalies de fonctionnement, appuyer sur le bouton de remise à zéro R.

Cette opération permet la réinitialisation de l'appareil.

L'affichage à l'écran du message d'erreur (**E**) suivi d'un chiffre **E** signale la position incorrecte de l'un des curseurs (de 00 à 25).

Réaligner le curseur en question pour rétablir le fonctionnement normal de l'appareil.

Caractéristiques techniques

- Appareil à usage domestique.
- Dispositif électronique à montage indépendant.
- Afficheur LCD.
- Alimentation : 3 piles alcalines LR6 1,5 V AA.
- Autonomie : au-delà d'1 an.
- Relais : tension maximum 250 V, courant maximum 5 A avec charge résistive (2 A avec charge inductive).
- Type d'action : 1B-U.
- Intervalle de détection de la température ambiante : 15 s.
- Différentiel thermique : de $\pm 0,1^{\circ}\text{C}$ à $\pm 0,9^{\circ}\text{C}$, sélectionnables.
- Résolution de lecture : $0,1^{\circ}\text{C}$.
- Champ de lecture visualisé : de 0°C à $+40^{\circ}\text{C}$.
- Précision : $\leq \pm 0,3^{\circ}\text{C}$.
- Logiciel classe A.
- Degré de pollution : 2.
- Tension d'impulsion : 4 kV.
- Température maximum de la tête de commande : 40°C .
- Température de fonctionnement : de 0°C à $+40^{\circ}\text{C}$.
- Degré de protection : IP30.
- Dimensions : 132x82x33,5 mm.



Programmierbare Thermostatsteuerung

FB00802-DE

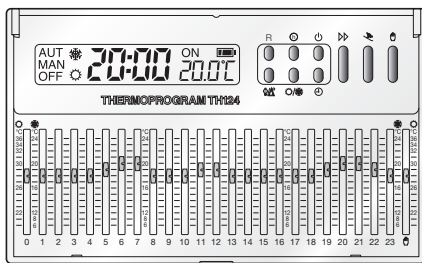

TH/124

MONTAGE- UND BETRIEBSANLEITUNG

DE Deutsch

Allgemeine Hinweise

- ⚠ Wichtige Sicherheitshinweise: **BITTE SORGFÄLTIG DURCHLESEN!**
- Sicherstellen, dass im Stromnetz gemäß den Installationsvorschriften eine omnipolare Schutzauslösungsreinheit, die das Gerät unter den Bedingungen der Überspannungskategorie III abtrennt, vorhanden ist;
- Die Montage, Programmierung, Inbetriebnahme und Wartung muss von ausgebildeten Fachtechnikern und gemäß den derzeit geltenden Vorschriften durchgeführt werden.
- Bei Eingriffen an der Steuerung, Antistatik-Schuhe und Kleidung anziehen.
- Diese Sicherheitshinweise aufbewahren.
- Vor der Reinigung und Wartung immer die Stromzufuhr unterbrechen.
- Das Produkt darf nur für den Verwendungszweck für den es entwickelt wurde, eingesetzt werden. Andere Verwendungszwecke sind gefährlich.
- Der Hersteller haftet nicht für Schäden, die durch den unsachgemäßen, falschen oder unvernünftigen Gebrauch verursacht werden.
- ⚠ Explosionsgefahr bei Verwendung von falschen Ersatzbatterien.
- Am Ende ihres Lebenszyklusses die Batterien nicht mit dem Hausmüll entsorgen, bitte getrennt sammeln und korrekt entsorgen.

ENTSORGUNG - Sicherstellen, dass das Verpackungsmaterial nicht in die Umwelt gelangt und gemäß den im Verwendungsland gültigen Vorschriften entsorgt wird.

Das nicht mehr benutzbare Gerät muss umweltgerecht entsorgt werden und darf nicht in die Umwelt gelangen. Das Gerät muss gemäß den geltenden Vorschriften entsorgt werden, dabei muss das Recycling der Bestandteile des Geräts bevorzugt werden. Die wiederverwertbaren Bestandteile des Geräts, sind mit einem Symbol und dem Material-Kürzel gekennzeichnet.

Bezugsnormen - Das Produkt entspricht den geltenden Richtlinien.

Beschreibung

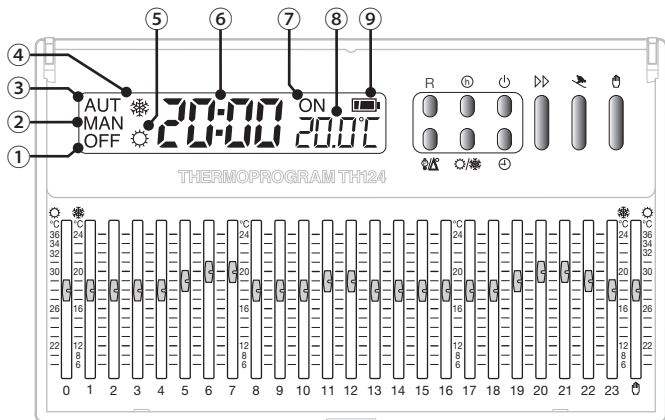

Beschreibung der Symbole auf dem Display

- | | | | |
|--------------|-------------------------------------------------------------|-------------|----------------------------|
| ① OFF | Von der Temperatursteuerung ausgeschlossene Temperaturzone | ④ | Heizbetrieb eingeschaltet |
| ② MAN | MANUELLE Steuerung der Temperaturzone ist eingeschaltet | ⑤ | Kühlbetrieb eingeschaltet |
| ③ AUT | AUTOMATISCHE Steuerung der Temperaturzone ist eingeschaltet | ⑥ | Digital-Uhr |
| | | ⑦ ON | Heiz-/Kühlgerät in Betrieb |
| | | ⑧ | Gemessene Temperatur |
| | | ⑨ | Batterieladestatus |

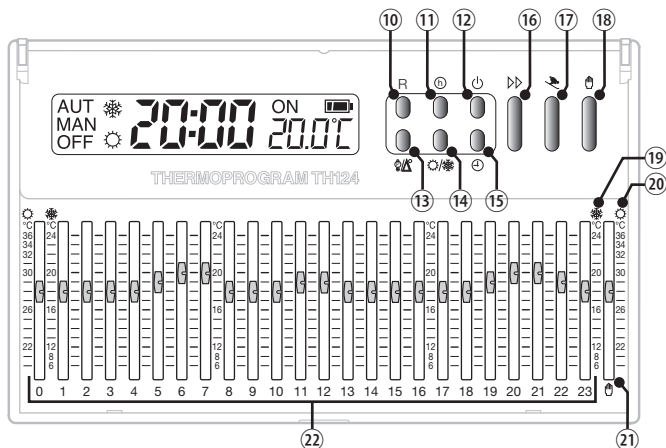

Funktion der Taster und Schiebetaster

- ⑩ R Rückstelltaste
- ⑪ Die Einschaltdauer der Anlage wird angezeigt
- ⑫ Die Temperaturkontrolle der Temperaturzone wird ausgeschlossen
- ⑬ Die Temperatur und das eingestellte Temperaturdifferential wird angezeigt
- ⑭ Die Betriebsweise der Anlage wird ausgewählt
- ⑮ Einstellung der Uhrzeit
- ⑯ Vorschubtaste
- ⑰ Urlaubsprogramm aktivieren

- ⑱ MANUELLE/AUTOMATISCHE Temperatursteuerung der Anlage wählen
- ⑲ Gültige Temperaturskala bei eingeschaltetem Heizbetrieb
- ⑳ Gültige Temperaturskala bei eingeschaltetem Kühlbetrieb
- ㉑ Schiebetaster für die manuelle Temperatureinstellung
- ㉒ Schiebetaster mit denen die Solltemperatur für verschiedene Uhrzeiten eingestellt wird

ACHTUNG!

Für die Reinigung nur leicht mit Wasser angefeuchtete, weiche Tücher verwenden.

Montage

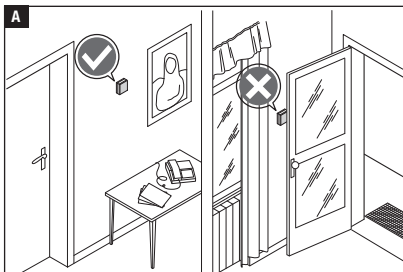

Das Gerät an einer für die Temperaturerfassung geeigneten Stelle montieren (möglichst an einer Innenwand, nicht in Nischen, hinter Türen oder Gardinen oder in der Nähe von Wärmequellen anbringen).

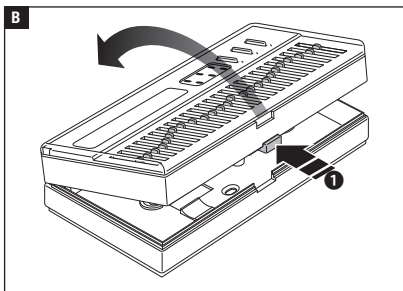

Auf die Taste **1** drücken und das Unterteil vom Gerät trennen **B**.

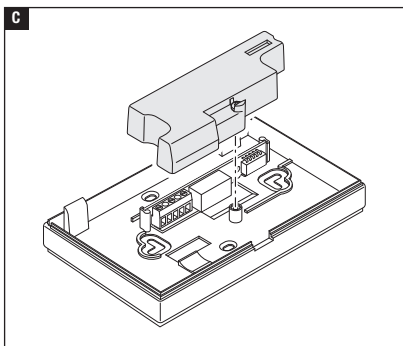

Die Schutzabdeckung der Klemmleiste entfernen **C**.

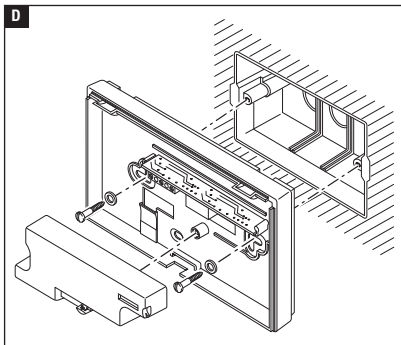

Das Unterteil an der Wand oder in der UP-Dose befestigen, dabei die Anschlussdrahre durch das entsprechende Loch ziehen **D**.

Hinweis. Die Schrauben nicht zu stark anziehen.

Elektrische Anschlusse

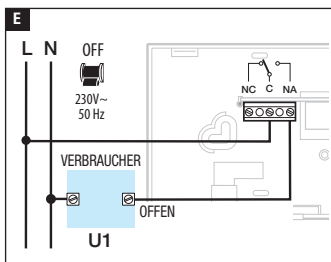

Der Anschluss hangt von den von der Thermostatsteuerung gesteuerten Geraten ab.

ZEICHENERKLARUNG

Netzstromleiter

N = Neutralleiter

L = Leiter

Relaiskontakte

C = allgemeiner

NO = normalerweise offener Kontakt

NC = normalerweise geschlossener Kontakt

Stromverbraucher

U1 = Brenner, Umwalzpumpe, Magnetventil, usw.

U2 = motorisiertes Ventil

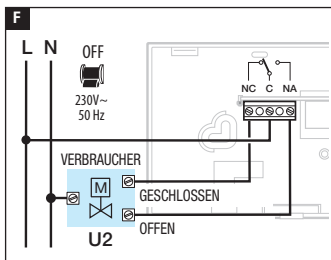

HINWEIS. Beim Anschließen die Anleitungen des zu steuernden Gerats beachten.

Die Klemmenabdeckungen wieder anbringen.

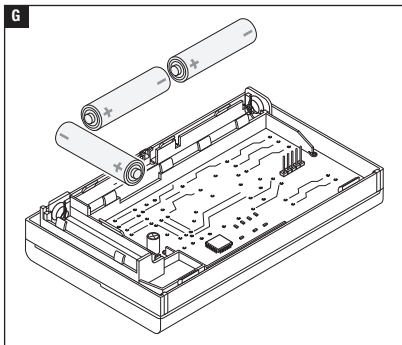

Drei Mignonzellen LR03 AAA zu 1,5 V in das entsprechende Fach stecken, dabei die im Batteriefach angegebene Polung berücksichtigen **G**.

⚠ Falsches Einlegen der Batterien kann Schäden verursachen.

Wenn die Display-Anzeige nicht innerhalb von 30 Sekunden sichtbar ist, auf den Rücksetztaster R drücken.

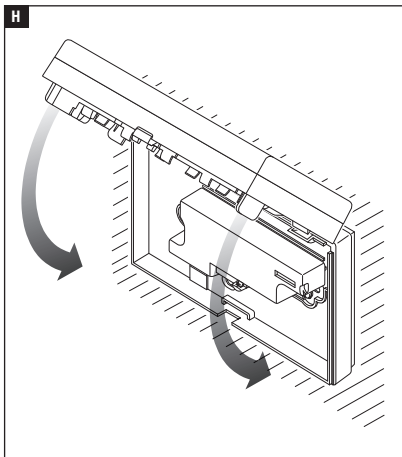

Das Gerät und die Grundplatte, wie in der Abbildung dargestellt, einrasten **H** eingeben.

Programmierung und Gebrauch des Geräts

Uhrzeit einstellen

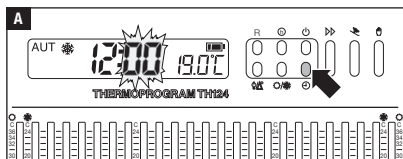

Drücken Sie auf die Taste  **A**.
Die Minuten blinken nun.

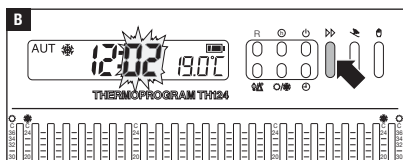

Mit der Taste  die genaue
Minutenzahl eingeben **B**.

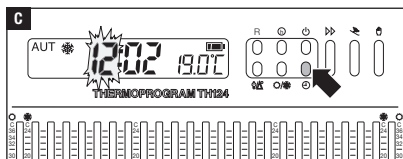

Drücken Sie auf die Taste  **C**.
Die Stunden blinken nun.

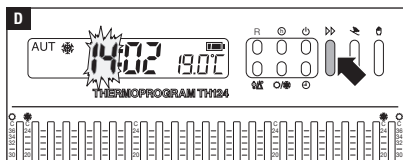

Mit der Taste  die genaue Stun-
denzahl eingeben **D**.

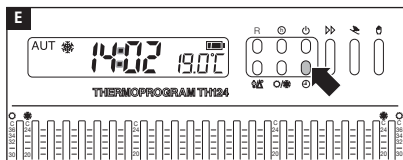

Drücken Sie auf die Taste , um
den Vorgang zu beenden **E**.

Die beiden Punkte zwischen der
Stunden- und Minutenanzeige
blinken, dadurch wird die Einstel-
lung bestätigt.

Hinweis. Nach jedem Druck auf die Taste  erhöht sich die Zahl auf dem Display um eine Einheit; durch ständigen Druck wechseln die Zahlen auf dem Display 5 Sekunden lang langsam und anschließend schneller.

Hinweis. Wenn das Gerät 10 Sek. lang nicht betätigt wird, beendet das Gerät den Vorgang automatisch und speichert die zuletzt eingegebenen Daten.

Betriebsart einstellen

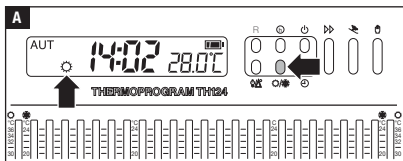

Drücken Sie auf die Taste  **A** drücken, um die Betriebsart der Temperaturzone zu wählen.

 Heizen.

 Kühlen.

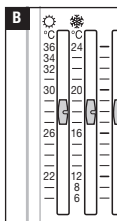

 Wenn der Kühlbetrieb eingeschaltet ist, können Sie mit den Schiebepastern Temperaturen zwischen 36°C und 34°C mit einem Intervall von 2°C und zwischen 32°C und 20°C mit einem Intervall von 1°C wählen.

 Wenn der Heizbetrieb eingeschaltet ist, können Sie mit den Schiebepastern Temperaturen zwischen 24°C und 12°C mit einem Intervall von 1°C und zwischen 8°C und 6°C mit einem Intervall von 2°C wählen.

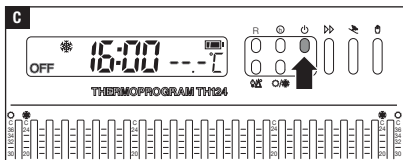

Die Anlage ausschließen

Drücken Sie auf die Taste  **C**.

Auf dem Display erscheint die Angabe OFF und die Ist-Temperatur wird 5 Sekunden lang nicht mehr angezeigt.

Das Gerät ist von der Temperaturkontrolle der Temperaturzone ausgeschlossen, die Uhr und die Ist-Temperatur-Anzeige sind weiter aktiv.

Drücken Sie auf die Taste , die Temperaturkontrolle der Temperaturzone wird wieder aktiviert.

AUTOMATISCHE oder MANUELLE Temperatursteuerung

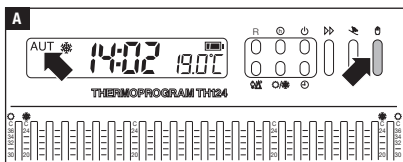

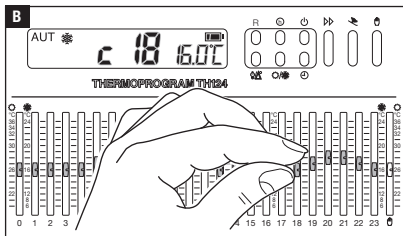

Automatische Steuerung

Drücken Sie auf die Taste  A, bis der Schriftzug **AUT** auf dem Display erscheint.



Die Schiebetaster 0 ÷ 23  so verschieben, dass für jede Stunde des Tages die Solltemperatur eingestellt wird.

Auf dem Display wird die Nummer des Schiebetasters, der verschoben wird und die eingestellte Temperatur angezeigt.

Die Temperaturskalen  und  entsprechend der Betriebsweise der Anlage berücksichtigen.
Hinweis. Die Einstellungen können jederzeit durch Verschieben der Schiebetaster verändert werden.

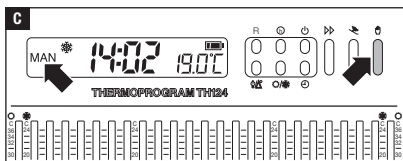

Manuelle Steuerung

Mit der Taste  C drücken, bis der Schriftzug **MAN** auf dem Display erscheint.

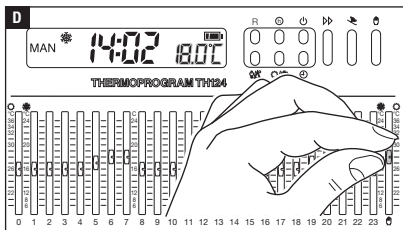

Mit dem Schiebetaster  D die Solltemperatur einstellen.

Auf dem Display wird die Temperatur, die gerade eingestellt wird, angezeigt. Die Temperaturskalen ❄️ und ☀️ entsprechend der Betriebsweise der Anlage berücksichtigen.

Verwendung des URLAUB Programms

Wenn für einige Stunden oder Tage eine bestimmte Temperatur bewahrt werden soll (z.B. Verlängerung der Wohlfühltemperatur bei nicht erwartetem Besuch, oder Frostschutztemperatur bei Abwesenheit im Winter) kann das URLAUB Programm aktiviert werden.

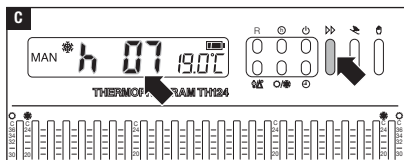
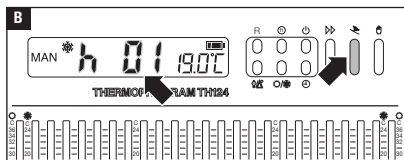
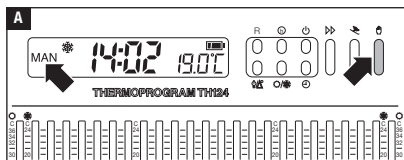

Die zeitgeschaltete Aktivierung beginnt sofort; auf dem Display werden die Stunden bis zur Beendigung des Programms angezeigt. Die verbleibende Dauer der laufenden Stunde wird als 1 Stunde angegeben.

Hinweis. Um vor Ablauf der eingestellten Zeit wieder auf AUTOMATISCHEN Betrieb zu wechseln, drücken Sie auf die Taste **A**.

Stundenschaltung

Den MANUELLEN Betrieb aktivieren **A**.

Mit dem Schiebeteaster die Solltemperatur einstellen.

Drücken Sie auf die Taste **B**. Auf dem Display wird an Stelle der laufenden Uhrzeit, der Schriftzug h01 angezeigt.

Mit der Taste die gewünschte Einschaltdauer in Stunden (von 1 bis 99) einstellen **C**.

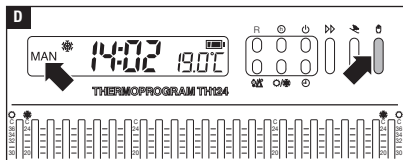

Tagesschaltung

Den MANUELLEN Betrieb aktivieren **D**.

Mit dem Schiebetaster  die Solltemperatur einstellen.

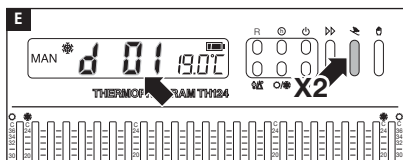

Drücken Sie zwei Mal auf die Taste  **E**.

Auf dem Display wird an Stelle der laufenden Uhrzeit, der Schriftzug d01 angezeigt.

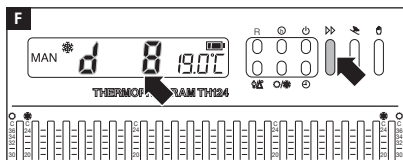

Mit der Taste  die gewünschte Einschaltdauer in Tagen (von 1 bis 99) einstellen **F**.

Die zeitgeschaltete Aktivierung beginnt sofort; auf dem Display werden die Tage bis zur Beendigung des Programms angezeigt. Die verbleibende Dauer des laufenden Tages wird als 1 Tag angegeben.

Hinweis. Um vor Ablauf der eingestellten Zeit wieder auf AUTOMATISCHEN Betrieb zu wechseln, drücken Sie auf die Taste  **D**.

Zeitgeschalteter Ausschluss der Temperaturregelung einer Temperaturzone

Das Programm funktioniert, wie das URLAUB Programm, allerdings wird der Ausschluss der Temperaturregelung zeitgeschaltet.

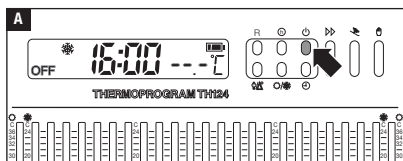

Stundenweiser Ausschluss

Mit der Taste  **A**.

Auf dem Display erscheint die Angabe OFF und die Ist-Temperatur wird 5 Sekunden lang nicht mehr angezeigt.

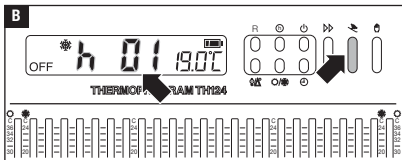

Mit der Taste  **B**.
Auf dem Display wird an Stelle der laufenden Uhrzeit, der Schriftzug h01 angezeigt.

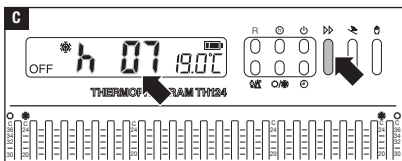



Mit der Taste  die Anzahl der Stunden, in denen die Temperaturkontrolle einer Temperaturzone ausgeschlossen werden soll (von 1 bis 99) eingeben **C**.

Der zeitgeschaltete Ausschluss beginnt sofort; auf dem Display werden die Stunden bis zur Beendigung des Programms angezeigt. Die verbleibende Dauer der laufenden Stunde wird als 1 Stunde angegeben.

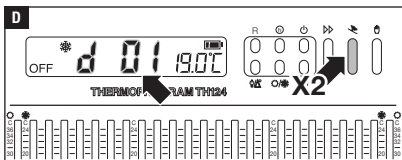
Hinweis. Um vor Ablauf der eingestellten Zeit wieder auf AUTOMATISCHEN Betrieb zu wechseln, drücken Sie auf die Taste .



Tagesweiser Ausschluss
Drücken Sie auf die Taste  **A**.
Drücken Sie zwei Mal auf die Taste  **D**.

Auf dem Display wird an Stelle der laufenden Uhrzeit, der Schriftzug d01 angezeigt.

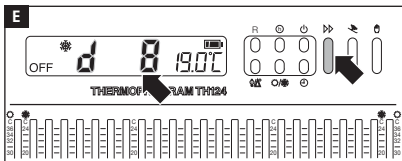

Mit der Taste  die Anzahl der Tage, an denen die Temperaturkontrolle einer Temperaturzone ausgeschlossen werden soll (von 1 bis 99) eingeben **E**.

Der zeitgeschaltete Ausschluss be

ginnt sofort; auf dem Display werden die Tage bis zur Beendigung des Programms angezeigt. Die verbleibende Dauer des laufenden Tages wird als 1 Tag angegeben.

Hinweis. Um vor Ablauf der eingestellten Zeit wieder auf AUTOMATISCHEN Betrieb zu wechseln, drücken Sie auf die Taste .

Änderung des Temperaturdifferentials

In der Werkseinstellung ist ein Temperaturdifferential von $\pm 0,2^\circ\text{C}$ eingestellt.

Dieses Temperaturdifferential eignet sich für Anlagen mit einer hohen thermischen Trägheit,

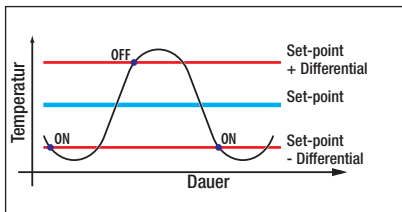

wie z.B. Gussheizkörper.

Sollte aufgrund der Beschaffenheit der Anlage eine Änderung des Differentials nötig sein, wie folgt vorgehen.

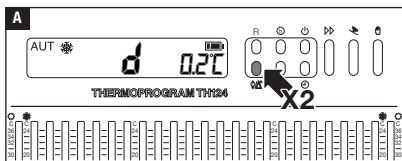

Drücken Sie 2 $\text{ⓧ}/\Delta^\circ$ Mal auf die Taste **A**.

Auf dem Display wird 10 Sekunden lang das eingestellte Temperaturdifferential angezeigt ($0,2^\circ\text{C}$).

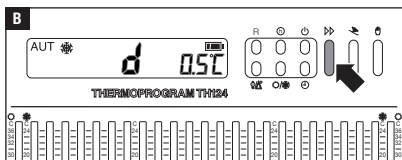

Drücken Sie auf die Taste $\triangleright\triangleright$ bis das gewünschte Temperaturdifferential (von $\pm 0,1^\circ\text{C}$ bis $\pm 0,9^\circ\text{C}$) erreicht wird.

Nach circa 10 Sekunden oder nachdem Sie wieder auf die Taste $\text{ⓧ}/\Delta^\circ$ gedrückt haben, wird auf dem

Display wieder die Uhrzeit und die Ist-Temperatur angezeigt.

Hinweis. Durch Druck auf die Taste **R** wird das Temperaturdifferential wieder in die Werkseinstellung zurückgesetzt ($\pm 0,2^\circ\text{C}$).

Die eingestellten Temperaturen anzeigen

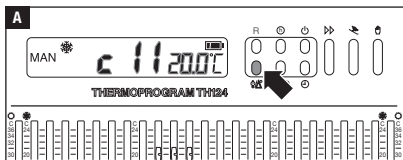

Drücken Sie auf die Taste .

Auf dem Display wird die für die angegebene Uhrzeit eingestellte Temperatur 5 Sek. lang angezeigt **A**.

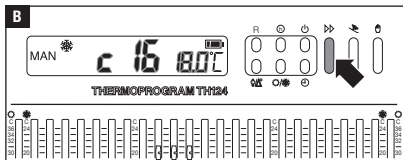

Z.B.: Wenn es 11:45 ist und der entsprechende Schiebeteaser (C1) auf 20°C eingestellt ist, wird auf dem Display C11 20°C angezeigt.

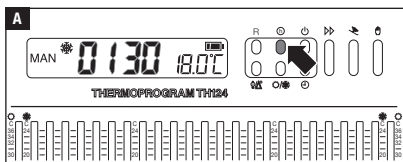

Drücken Sie auf die Taste , um die mit verschiedenen Schiebeteasern für die anderen Stunden des Tages eingestellte Temperatur anzuzeigen. C25 ist der Schiebeteaser der manuell eingestellten Temperatur.

Betriebsstunden der Anlage





Drücken Sie auf die Taste .

Auf dem Display wird 5 Sek. lang die Anzahl der Betriebsstunden des mit der Thermostatsteuerung verbundenen Kühl-/Heizsystems angezeigt **A**.

Um das Zählwerk auf Null zu stellen, hintereinander (innerhalb von 5 Sekunden) auf die Taste  und danach auf die Taste  drücken.

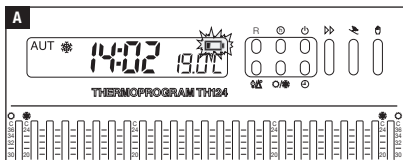
Batteriewechsel



Das Symbol  auf dem Display blinkt **A** und zeigt somit an, dass die Batterien innerhalb von ca. 1 Monat gewechselt werden müssen.

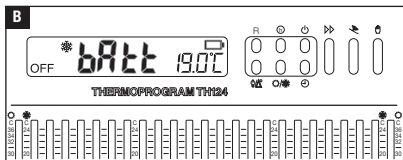

Wenn auf dem Display die Angaben **batt** +  erscheinen, funktioniert das Gerät nicht mehr und die Temperatursteuerung der Temperaturzone ist ausgeschaltet.

ACHTUNG: Wenn die Batterien nicht rechtzeitig gewechselt werden, kann die Heizanlage beschädigt werden.

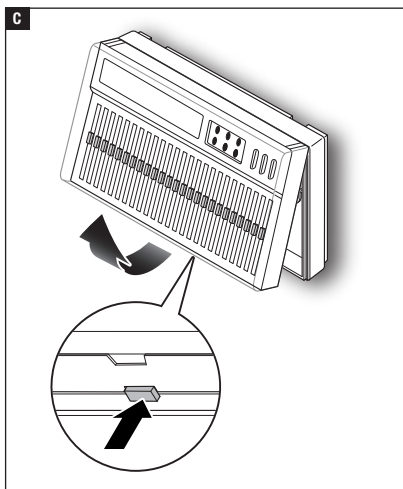

Die Taste unten drücken und das Gerät öffnen **C**.

Wenn dies bei blinkender Batterieanzeige gemacht wird, verschwinden sämtliche Display-Anzeigen.

Die Batterien müssen innerhalb von ca. 2 Minuten ausgetauscht werden; danach werden die Einstellungen auf die Werkseinstellung zurückgesetzt.

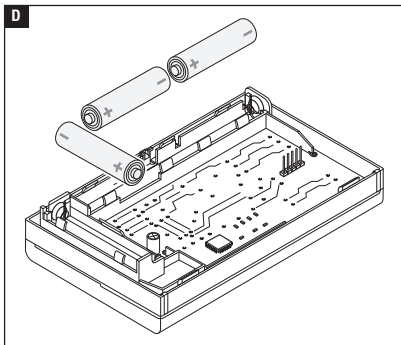

3 neue LR6 Mignonzellen - AA zu 1,5 V - desselben Typs einlegen, dabei die auf dem Boden des Batteriefachs angegebene Polung berücksichtigen eingeben **D**.

Sollte die Display-Anzeige nicht innerhalb von 30 Sek. erscheinen, auf den Rücksetz-Taster R drücken.

Achtung. Das Gerät kann infolge falsch eingelegter Batterien beschädigt werden.

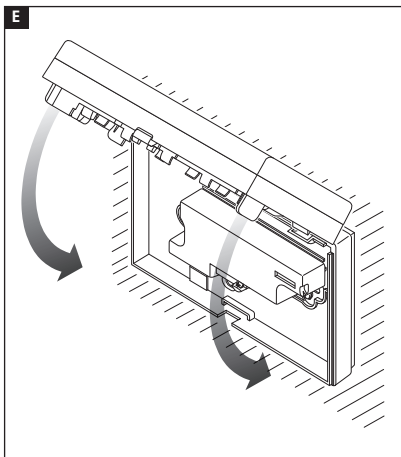

Das Gerät schließen, darauf achten, dass die Haken richtig einrasten **E**.

Nach einigen Sekunden ist die Display-Anzeige wieder sichtbar.

Störungsbehebung

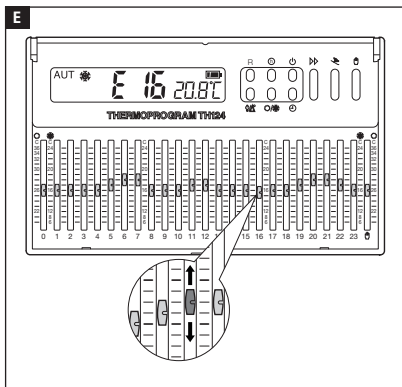

Im Fall von Störungen, den Rücksetztaster R drücken.

Dadurch werden die Werkseinstellungen zurückgesetzt.

Wenn auf dem Display eine Fehlermeldung (E) auf die eine Nummer folgt, angezeigt wird **E**, bedeutet dies, dass einer der Schiebetaster (von 00 bis 25) falsch eingestellt wurde.

Den gekennzeichneten Schiebetaster in die richtige Stellung schieben, um den normalen Betrieb wieder aufzunehmen.

Technische Daten

- Heimgerät.
- Unabhängig montiertes elektronisches Gerät.
- LCD-Display.
- Spannungsversorgung: 3 Mignonzellen LR6 AA zu 1,5V.
- Lebensdauer: > 1 Jahr.
- Relais: Höchstspannung 250 V, ohmsche Höchstlast 5A (induktive Höchstlast 2A).
- Aktionstyp: 1B-U.
- Erfassungsintervall Raumtemperatur: 15 Sek.
- Temperaturdifferential: von $\pm 0,1$ °C bis $\pm 0,9$ °C, auswählbar.
- Lese-Auflösung: $0,1$ °C.
- Angezeigter Temperaturbereich: von 0 °C bis $+40$ °C.
- Messgenauigkeit: $\leq \pm 0,3$ °C.
- Software Klasse A.
- Verschmutzungsgrad: 2.
- Impulsspannung: 4 kV.
- Höchsttemperatur Steuerkopf: 40 °C.
- Betriebstemperatur: 0 °C bis $+40$ °C.
- Schutzart: IP30.
- Abmessungen: 132x82x33,5 mm.

CAME 
BPT

CAME.COM

CAME S.P.A.

Via Martiri Della Libertà, 15
31030 Dosson di Casier - Treviso - Italy
tel. (+39) 0422 4940 - fax. (+39) 0422 4941